



# Intelligent Modularity

Elabo test equipment for safety and functionality tests



Almost unlimited deployment possibilities, robustness and flexibility have always been the characteristics of all Elabo products. One thing helps us here: always being attentive to and present in the market. It is important for us to always maintain dialogue with our customers.

This allows us to react systematically to changing conditions. This provides you the advantage of always receiving the devices and systems precisely tailored to your requirements.

The best possible combination of the latest technologies, optimum user-friendliness and perfect ergonomics – that is our constant aim!

The market proves us right. Elabo products are still market leaders.



## Elabo measuring and testing devices

With the measuring and testing devices in the BestPerformance and HighPerformance lines and an extensive assortment of other measuring and testing devices, Elabo offers a complete product portfolio of robust, economical equipment for long-term industrial use. The latest technology

„Made in Germany“ – economical and reliable.



## Elabo – the system provider.

Starting with test devices, extension modules and the complete range of accessories – the right solution for every application.

Either as an individual solution, complete solution or as a module for OEM customers.

For manual operation, or as a fully automatic solution.

Controlled by interfaces, the modern Touch user interface or using the comprehensive Elution PC software.

The advantage to you: a device program for all applications.

Elabo – always a reliable partnership.



## Contents

	ab Seite
<b>Intelligent Modularity</b>	2
<b>BestPerformance – Superior Technology</b>	4
<b>HighPerformance – Superior Design</b>	6
<b>PC-Software ElutionDevice</b>	10
<b>Elabo Service</b>	12
<b>High-voltage test devices</b>	14
Variations	16
Devices BestPerformance / HighPerformance	19
Sample configurations	34
<b>Combi-test devices</b>	38
Variations	40
Devices BestPerformance / HighPerformance	43
Sample configurations	56
<b>Protective earth conductor resistance testing devices</b>	60
Variations	62
Devices	63
Sample configurations	69
<b>Insulation resistance testing devices</b>	70
Variations	72
Devices	73
Sample configurations	77
<b>Leakage current measuring devices</b>	78
Variations	80
Devices	81
Sample configurations	89
<b>Other measuring and testing devices</b>	90
Current- /Voltage measuring devices; Treshold value module	93
Multi-meter	95
High-voltage multi-meter with load unit	97
Resistance measuring devices	99
Power Supply AC	103
Power Supply DC	107
<b>Accessories</b>	108
<b>Other components for setting up testsystems</b>	124
Control units	126
Rack units	127
<b>Samples of test systems</b>	128
<b>PC-Software for test systems</b>	132
<b>References</b>	134
<b>Index of order numbers</b>	135

# Superior technology

Flexible in use – robust construction – optimum user-friendliness

## Elabo **BestPerformance**

### 19"-plug-in technology

...guarantees modularity and flexibility. The consistent design using 19"-plug-in technology allows all components to be used interchangeably. In a rack or in a housing. Robust handles make handling easy.

### BestPerformance series

Economical and user-friendly. The black-and-white touch panel makes it easy to operate the testing devices, which are equipped as standard with an Ethernet interface (optionally RS232C or USB). All devices are also available without a control module, for use in automated systems, for instance.





## Additional types of devices

Various individual quality assurance test units round out Elabo's product range. Whether for manual use or as system building blocks, using the integrated digital interfaces – with Elabo you will find a suitable product for all applications. The Elabo brand stands for robustness combined with highly accurate measurements.

## High-quality metal housing

Consistent housing design using metal construction ensures robustness and smooth operation. This guarantees the long service life of our products and increases the cost-effectiveness of your investment.

## Access prevention

Access is effectively prevented by programmable password levels. In this way, only authorized persons can operate the equipment after it has been switched on.



## Easy servicing

Only a few simple steps are required to replace a device. Pluggable connections simplify maintenance and calibration.

## Interfaces

Whether via digital/analog interface or optional RS232-C, the remote control capability of the basic components allows them to be flexibly integrated into control systems.

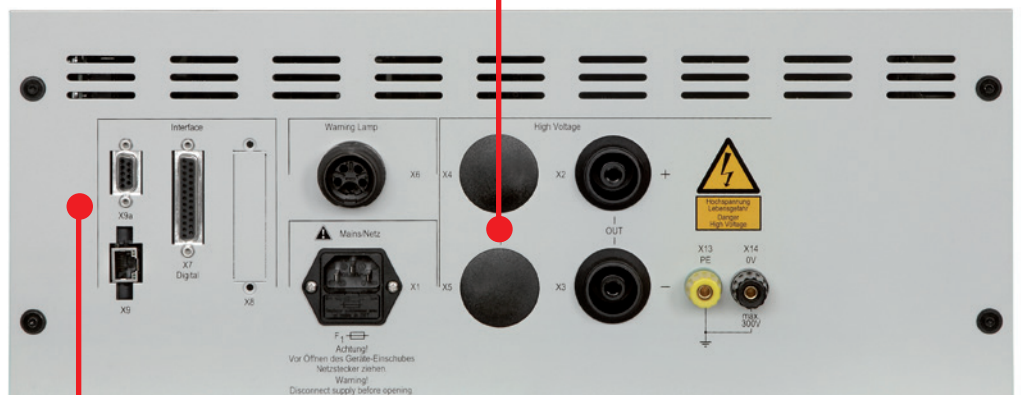

## Interfaces

Whether via Ethernet, RS232-C, or USB, the remote control capability of the components allows them to be integrated flexibly into control systems. The digital I/O interface links the system to external accessories.

# Superior design

Versatile in use – robust construction – optimum user-friendliness

## Elabo HighPerformance

### 19" drawer technology

... guarantees modularity and flexibility. Systematic execution with 19" drawer technology makes all components universally usable, in a rack or housing. Sturdy handles facilitate handling.

### Flexibility in detail

Depending on the respective application, the test voltage can either be drawn from the front or rear of the device. The voltage feedback for contact monitoring can also be optionally effected on the rear of the device.

### HighPerformance series

Modular and user-friendly. The ergonomic multicolour touch panel makes it easy to operate the testing devices, which are equipped as standard with an RS232-C (optionally Ethernet or USB). All devices are also available without a control module, for use in automated systems, for instance.



### TouchMe- maximum ease of operation

For convenient manual use of the test devices, versions with an ergonomically operated 6.5" touch display are available. An embedded system under Windows CE® forms the core component of this technology.

### High-quality metal housing

The systematic housing design executed in metal guarantees robustness and trouble-free operation. This ensures a long service life of our products and increases the profitability of your investment.

### Electronic voltage source

Rapid, precise and variable.  
Parameterisable ramp slopes.  
Different triggering modes.

### Interference resistance

Voltages up to 12.000 VAC  
and 16.000 VDC. Always one  
step ahead – optical fibers  
ensure reliable and interference-  
free signal transmission in the  
device.

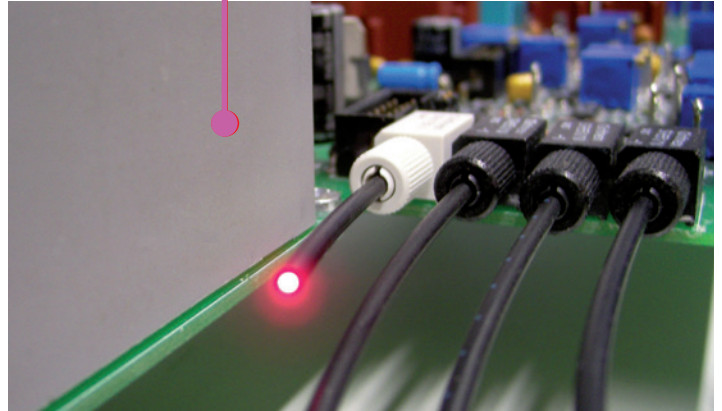

### Service-friendliness

A device can be replaced in  
next to no time. Plug con-  
nections facilitate mainte-  
nance and calibration.

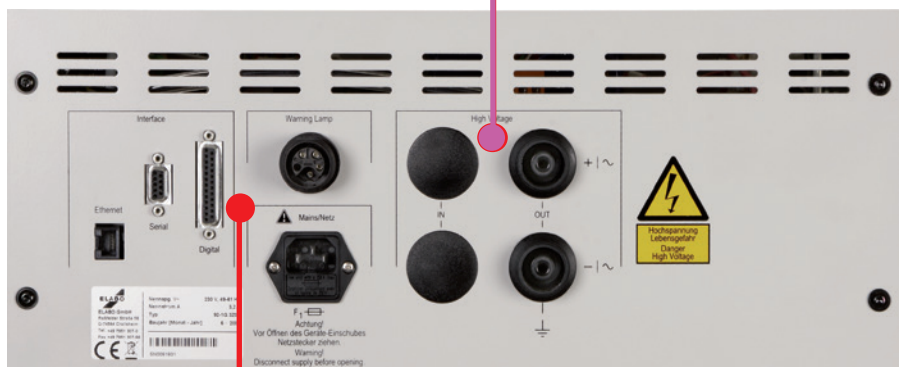

### Interfaces

Whether via RS232-C or via  
Ethernet or USB. The remote  
controllability of the components  
allows flexible integration in  
control systems. The digital I/O  
interface couples the system to  
external accessories.

### Access blocking

Parameterisable password levels  
guarantee effective access pro-  
tection. Only authorised users  
can operate the device after  
switching on.

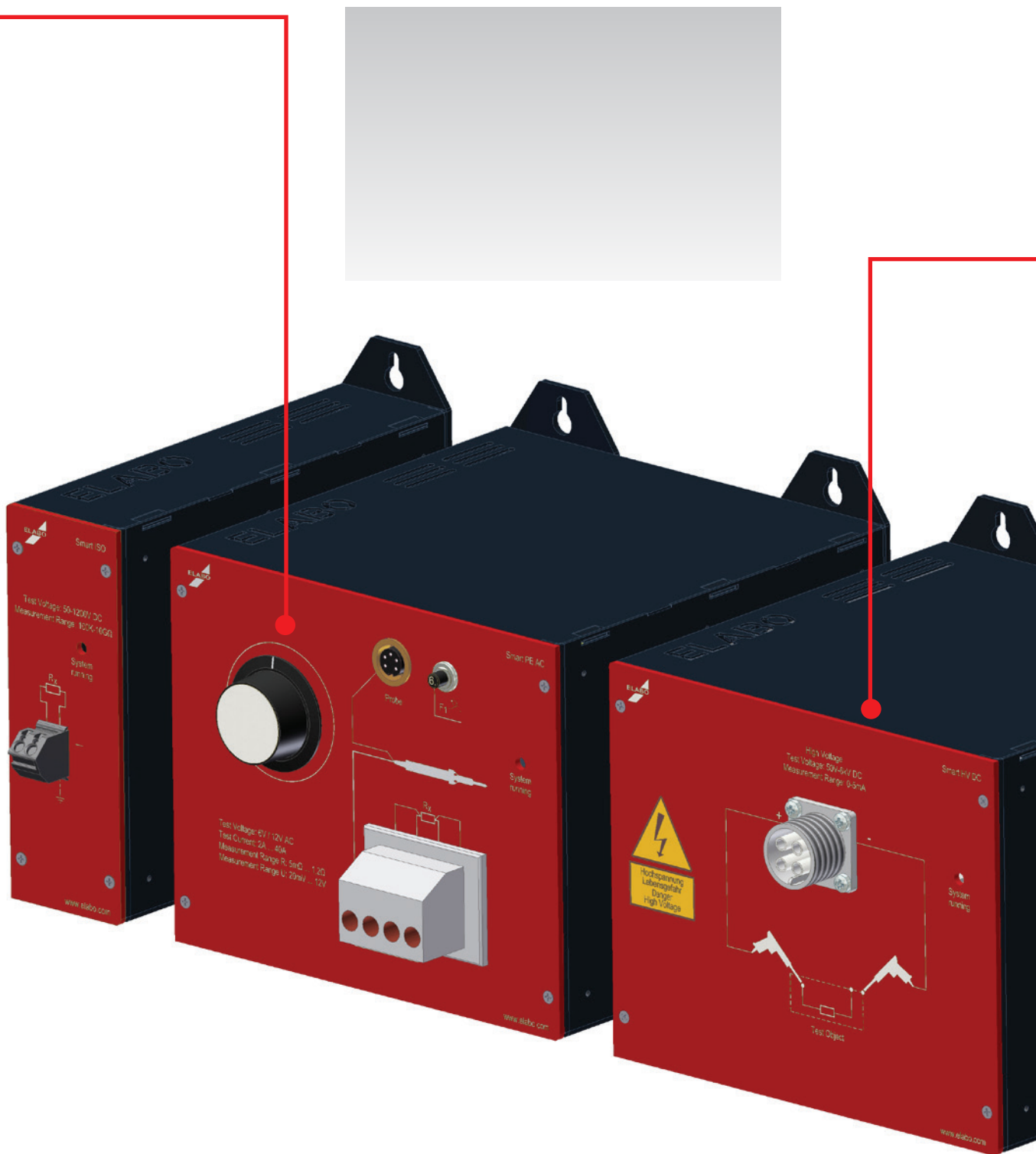



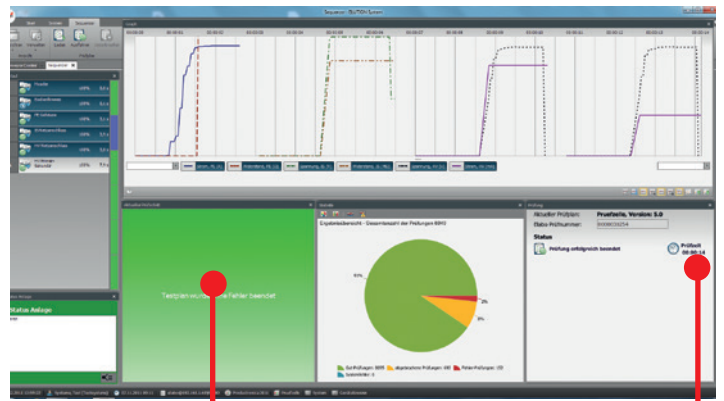

Sicherheitstester

Value1 Value2 Time

Status / Fehler

Widerstand Ist [HΩ] 1. Start Stop

FastMode  Einzelwert  Zweiwert  Details zeigen

HV	IS	PE	INPUT	OUTPUT
--- Spannung ---				
Spannungstyp: DC		Prüfmodus: HV		
Spannungsbereich [V]: 0		Prüfspannung [V]: 0		Mindestspannung [V]:
<input type="checkbox"/> Hochlauf [V/s]:	Startspannung [V]:		<input type="checkbox"/> Rücklauf [V/s]:	
--- Strom ---				
Auslöseart: Strom (Istwert)				
Messbereich: 0,5mA	Auslösestrom [mA]: 0,5		<input checked="" type="checkbox"/> Mindeststrom [mA]: 0	
--- Zeit ---				
<input type="checkbox"/> Dauertest	Prüfzeit [s]: 2,0		<input type="checkbox"/> Totzeit [s]:	
--- Startoptionen ---				
<input type="checkbox"/> Warte auf SK	<input type="checkbox"/> Warte auf Digital	Timeout [s]: 10		
<input type="checkbox"/> mit steigender Flanke	<input type="checkbox"/> mit steigender Flanke			
--- Voreinstellungen ---				

# TouchMe – control module

Control at its perfection

## Fingertip sensitivity in detail

The device versions equipped with the modern TouchMe control module can be operated ergonomically by touching the display with the finger. An embedded system under Windows CE® forms the core component of this technology.

A clearly arranged menu-controlled user interface with large touch buttons ensures that operation of the HighPerformance equipment series is child's play. The individual areas are safeguarded against unauthorised operation by multistage password protection. Consequently, only authorised users are capable of changing parameter settings, equipment settings or test plans for example.

## Elabo **HighPerformance**

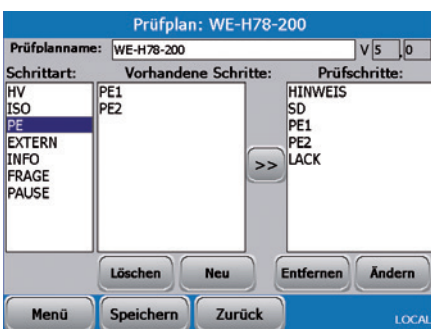
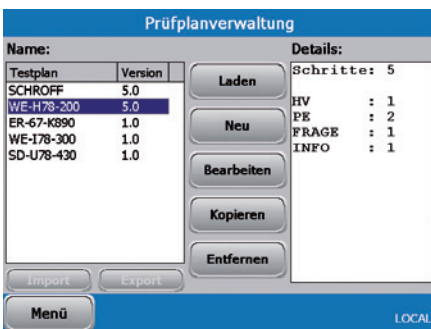
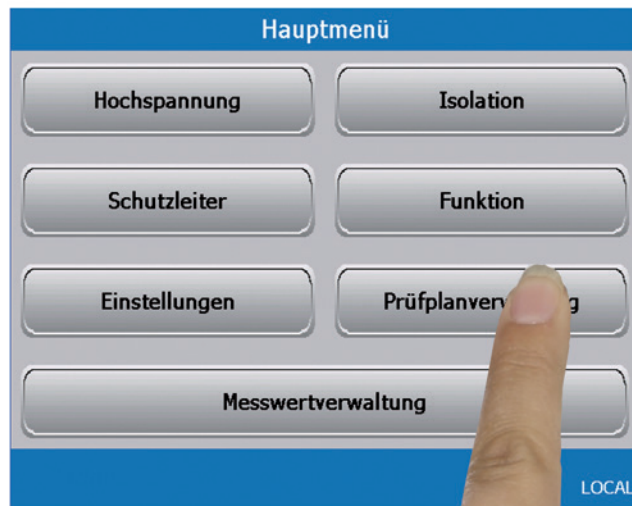

## Integrated test plan management

In addition to the possibility of being able to run tests individually, the control concept offers a convenient editor for preparing product-specific test plans. Alongside the basic test types, additional stages such as issue of user instructions or inquiries and activation of an external switching matrix can be integrated in the test sequence. The number, sequence and contents of the individual test stages can be individually parameterised by the user. This functionality which was formerly reserved above all for PC-controlled systems makes the tester a genuine test computer. The additional possibility of being able to define global test stages considerably facilitates preparing of test plans.

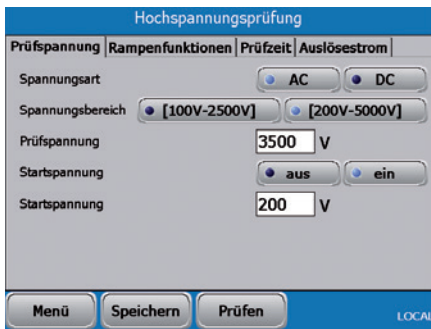

### Individual testing

The test devices can also of course run individual tests in manual mode. Individual settings for the test parameters can be made for this purpose. Parameterised individual tests can also be saved and are available as a global test stage in the test plan editor.

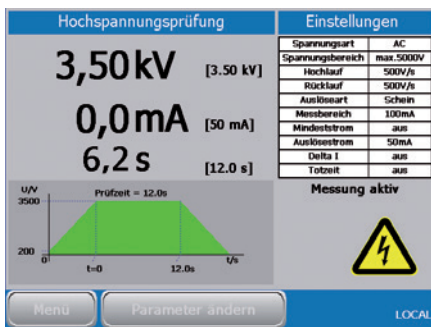

Detailed information concerning the test parameters and test status are displayed in test mode.

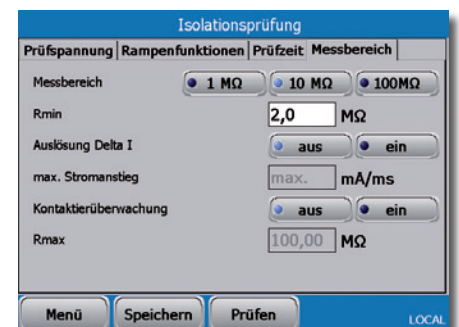

### National languages

The language of the user interface can be changed to different national languages. In addition to German and English, a selection of other languages is available on request.

### Extensions

In addition to the integrated remote control interface, a further Ethernet interface allows creation of an intrasystem equipment network for integration of additional extensions such as leakage current or functional test modules. Likewise, the number of additional inputs and outputs can be increased by connection of an external coupler. Through the latter, system extensions are almost unlimited.

### Additional equipment

In addition to the test-specific settings, the system manages additional useful functions. It is possible to both produce protocol printouts and save measured values on a USB stick for further processing on a PC. For this purpose, a USB accessory interface allowing integration of external components is incorporated in the device.

Examples:

- USB memory stick
- USB keyboard
- USB mouse



# PC-Software ElutionDevice

## Additional benefits for Production and Quality Assurance



In addition to the test devices that it markets, Elabo also offers a range of comprehensive software packages for conducting computer-controlled testing. Even the basic versions of the software suite Elabo ELUTION, which has been specifically designed for this purpose, provide comprehensive solutions for typical applications.

Elabo **ElutionDevice** simplifies the testing of electrical and electronic components used in research and development, production and quality assurance, as well as in Service and Repair.

### Applications in Production and Quality Assurance

1. Use Elabo ElutionDevice to define a sequential test run with chronologically executed test steps, running in semi-automatic or fully automatic mode.
2. Integrate test instructions, digital images or servicing steps into the test sequence, as required.
3. Work with product identifiers such as bar codes, etc. and track the values of a product throughout its entire lifetime.
4. Measurements and results are stored in an SQL database from which you can call them up at any time.
5. Manage program settings and user profiles, and limit access rights.
6. Prepare individual logs and printouts or export data to other programs for further processing.



For further information, please request our prospectus on Elabo ELUTION.

We would also be glad to provide you with a free DEMO Version.

### Further software packages from the Elabo ELUTION suite:



#### ElutionSystem

Software functionality for automated TestSystems



#### ElutionTraining

Software functionality for training and teaching



#### ElutionOffice

Evaluation and management of data and measurements

## Integrated program modules in ElutionDevice:

<b>System</b>	System, user and group management, update functions
<b>Interactive Window</b>	Manual test sequence, graphic display, logging and export function
<b>Sequencer</b>	Sequential test runs, statistics and graphic display
<b>Test plans</b>	Preparation of a test plan, block and template management
<b>Reports</b>	Readings browser, report printout and export function
<b>Expansion options</b>	
<b>Report Designer</b>	Prepare and manage individual report templates

### General data

- Scope of delivery: 1 DVD box including ElutionDevice, SQL Server Express operating instruction and online help
- Licence: Single workstation
- Languages: German and English, others available on request
- Operation: Mouse, touch with Windows Look & Feel; multiple monitoring possible
- Operating systems supported: Windows XP, Windows 7
- Recommended system: Dual Core CPU 2.6 GHz; 2 GB memory; 256 MB GPU graphic memory
- Requirements: Devices with Ethernet interface, additional device licences, .NET framework installed
- SQL platform: Local database or server solution
- Programming language: C#

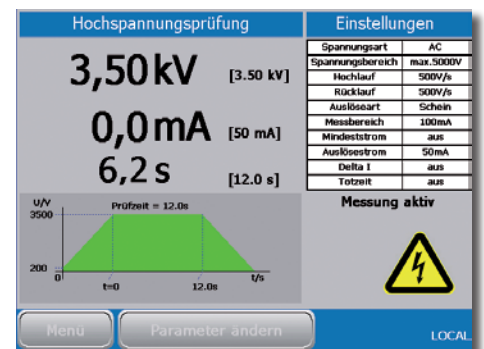

# Elabo service

Comprehensive, competent, rapid  
and reliable!

Do you have any further enquiries or require additional information?

Call us. We are at your disposal!

Email: [service@elabo.de](mailto:service@elabo.de)

Phone: + 49 7951 307-202

Fax: + 49 7951 307-67

**We do many things differently from other companies!**

We attach great importance to being at your disposal. For us, this is a matter of course, since even during ongoing operation, problems may arise that you can no longer solve yourself. This is when we are on hand.

Products from Elabo fulfil the highest demands in terms of quality; nevertheless, faults may occur over the years.

Your operating staff trained by us can fall back on us at any time by telephone in order to get production rolling again as quickly as possible.

Our service team is always at your disposal. Even directly on site on your premises if necessary, as fast as possible.

Our service also however covers your being able to deliver the test device to be repaired to us and wait for the repair.





### Repair service

Elabo test devices are used in demanding production sequences, often 24 hours a day and 7 days a week. All our products are characterised by the highest quality, reliability and durability and guarantee smooth functioning. Should however the eventuality arise, you are in good hands at Elabo. Nobody is better acquainted with our devices than ourselves. Consequently, repairs by Elabo as the manufacturers have considerable advantages over outside repairs.

### Calibration service

We consider we have a duty as manufacturers of safety testing devices and test systems. It is exactly for this reason that we have set up a works calibration laboratory. Above all individual devices are restored to "normal" here. Nobody is better acquainted with our devices than ourselves. Consequently, calibration by Elabo as the manufacturers has considerable advantages over outside calibration. So that you do not need to worry if the worst comes to the worst, we offer maintenance/calibration contracts.



### Hire/lease equipment service

In order to ensure that you are still able to guarantee the necessary quality assurance and documentation in case of a repair or calibration, we maintain a pool of hire and lease equipment.

These are above all HV, PE, IS and LC devices that we make available to you during the repair/calibration on our premises.



### What we can also do for you!

Firmware or hardware updates are installed automatically during a repair on our premises. You will therefore always have a device that is up to date.

# High-voltage test devices

User safety – combined with precision



## Why conduct high-voltage testing?

Guaranteeing product safety is regulated in practically all international standard guidelines. A high-voltage test must almost be performed as proof of product safety.

The Elabo product range offers a widely varied spectrum of different devices and add-on modules. Consequently, all test duties can be perfectly fulfilled.

In order to guarantee the user the necessary safety during device testing, all test devices in the Elabo range fulfil without exception the guidelines of EN50191 (VDE0104).

Elabo – a guarantee of reproducible and always absolutely reliable test systems compliant with standards.

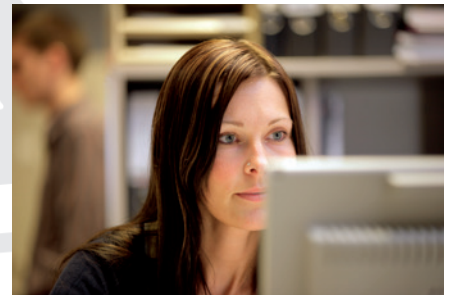

Hochspannung  
Lebensgefahr



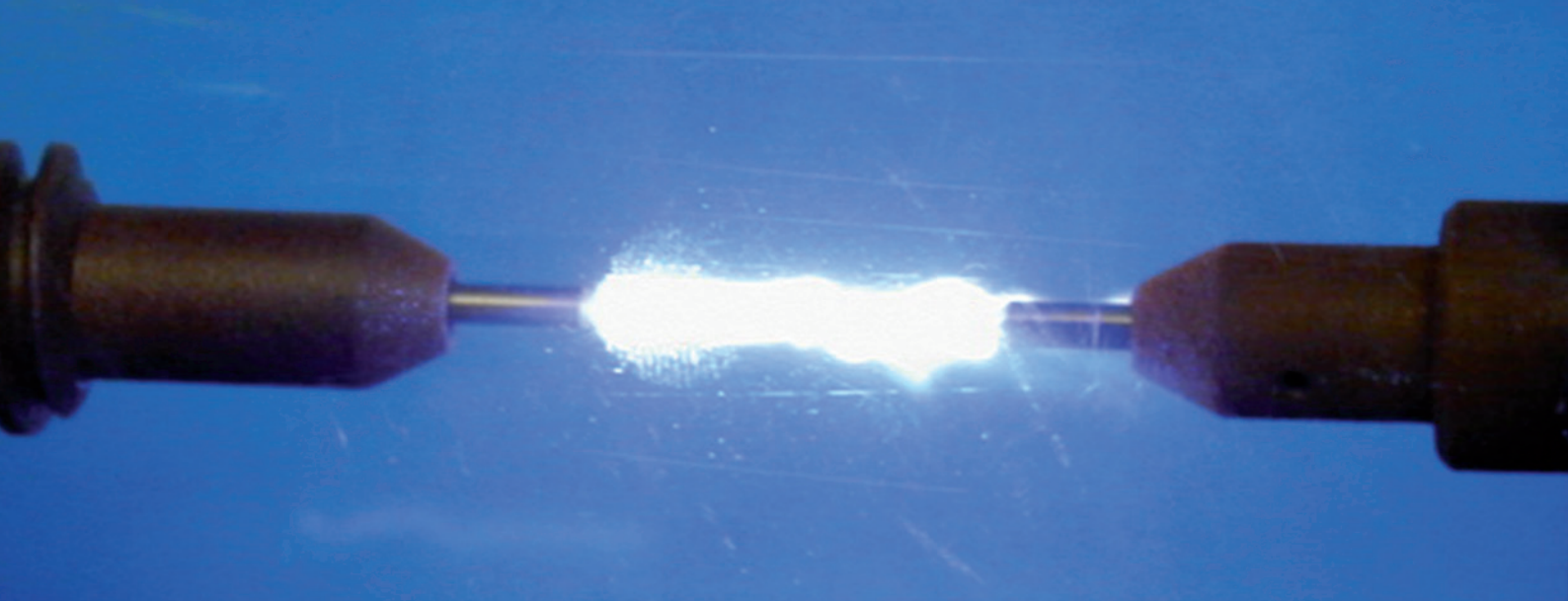

### High-voltage testing!

High-voltage testing serves for verification of the insulation resistance and voltage endurance on devices, machines, components and insulating materials. During the test process, voltages are applied to the test pieces that do not arise during use as intended.

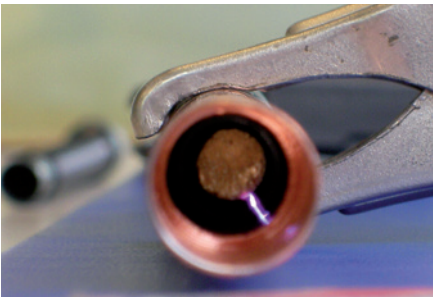

During high-voltage testing, changes in materials such as deteriorating insulating properties for example in addition to faults during processing (e.g. loose terminal clamps or damaged insulation) are detected. Furthermore, proper dimensioning of air gaps and creepage paths in addition to selection of the suitable insulating materials is verified.

Common test voltages lie within the range of 1000 – 2500 V, but may however exceed 10.000 V in specific cases. High-voltage testing involves considerable risks for the operators. Consequently, it is essential to observe safety precautions, as stipulated in EN50191 (VDE0104) for example.

Elabo offers a comprehensive range of accessories in order to guarantee user protection.

Whether as a single workstation solution or a partly or fully auto-mated test system. In the workshop, in the laboratory or in serial production. Elabo test devices are markedly superior through their widespread and flexible versatility. All test devices are already equipped in the basic version for the majority of applications and can also be subsequently adapted by appropriate add-on modules to modified and extended requirements.

**Elabo – always solutions with a secure future.**

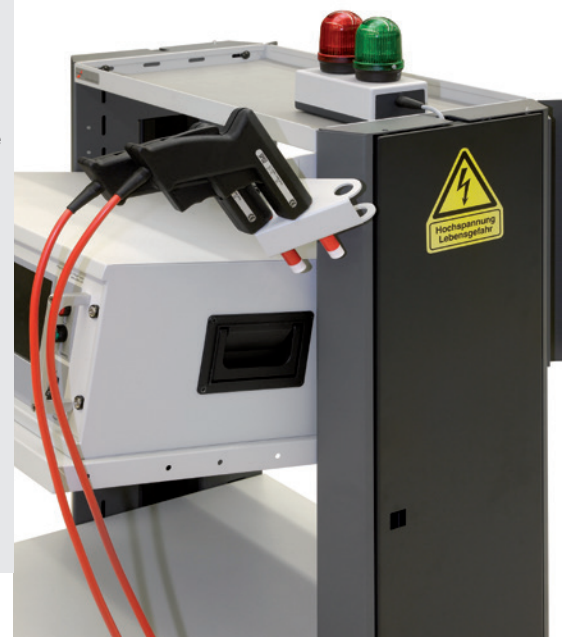



# Elabo **BestPerformance**



Device	G1-1A	G1-1M	G1-1B	G1-1N	G1-1G	G1-1T
Page	19	19	21	21	23	23

Application fields						
Manual use						
Automated use						

Measurement types						
High-voltage AC						
High-voltage DC						
Insulation resistance measurement						

Extensions						
Current limitation (EN50191)						
Burn-Mode						
Voltage readback						

Flexibility is of prime importance with Elabo. That is why two versions of the devices in this line of equipment are available. Depending on the purpose, universal use or fully automated operation are possible.

# Elabo High Performance



F1-1A	F1-1M	F1-1B	F1-1N	F1-1C	F1-1P	F1-1D	F1-1Q
25	25	27	27	29	29	31	31











● Standard    ○ Optional

Elabo: For each application the optimal solution!





Technical data:	<b>G1-1A / G1-1M</b>
Test voltage:	0.05 .. 6.00 kV
Output:	30 W
Tripping current:	0 .. 500 $\mu$ A • 0 .. 5.00 mA
Interface:	Ethernet • digital interface 1
Line voltage:	230 V / $\pm$ 10 %; 49 .. 61 Hz
Dimensions:	19" / 4 HU; depth 360 mm
Weight:	15 kg / 14 kg

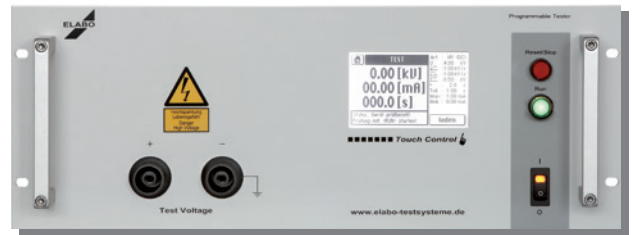

Front view G1-1A



Front view G1-1M



Rear view G1-1A, G1-1M

### High-voltage testing device direct current (DC)

The testing device, which is available also as an automatic device, allows flexible possibilities for use in manual and automated systems – for high-voltage testing and optionally for measurement of insulation resistance in systems, assemblies and components. For more detailed technical data, please see the table on back.

	Description	Dimensions	Item no.
High-voltage testing device DC	incl. touch control unit	19" / 4 HU	G1-1A
High-voltage testing device DC	for use in automated systems	19" / 4 HU	G1-1M

### Extension modules for the testing devices

	Technical data	for device type	Item no.
Insulation resistance measurement	Measurement range 2.50 / 25.0 / 50.0 M $\Omega$	G1-1A; G1-1M	G1-1A E02
Voltage readback	The module allows four-wire measurement by reading back the test voltage. Two high-voltage receptacles are also built into the back wall of the device	G1-1A; G1-1M	G1-1A E04
Additional digital outputs	Six additional digital outputs for controlling an external switching matrix	G1-1A; G1-1M	G1-1A E06
RS232-C	Alternative interface to Ethernet interface	G1-1A; G1-1M	G1-1A E11
USB	Alternative interface to Ethernet interface	G1-1A; G1-1M	G1-1A E12
Software package	ElutionDevice software package	G1-1A; G1-1M	N2-1A Z7A
Device driver	On request		
Calibration	Delivery with Elabo works calibration protocol	G1-1A; G1-1M	G1-1A E99
Calibration	Delivery with Elabo works calibration protocol when the "insulation resistance measurement" extension function is integrated	G1-1A; G1-1M	G1-1A E99-02

The description of the accessories can be found starting on page 108. Please also see our sample configurations starting on page 34. Technical specifications subject to change without notice.

## Device features G1-1A / G1-1M

**Elabo** BestPerformance

Device	G1-1A	G1-1M
<b>Applications</b>		
Manual use	●	
Automated use	●	●
<b>Operation</b>		
Touch display 4.3"	●	
<b>Interface</b>		
Start button	●	●
Reset button	●	●
<b>Interfaces</b>		
Ethernet	●	●
RS232-C	○	○
USB	○	○
Digital interface 1	●	●
Digital interface 2	○	○
2 Safety circuits	●	●
D/A Extension module	○	○
<b>Connections</b>		
Test probes front and back	●	●
Warning light connection at back	●	●
IEC connector at back	●	●
<b>Tests</b>		
High-voltage AC		
High-voltage DC	●	●
Insulation resistance measurement	○	○
Voltage readback	○	○
<b>Test voltages</b>		
Test voltage	0.05 .. 6.00 kV	
Residual ripple DC	< 0.1 %	
Adjusting speed ramp	0 .. 1 kV/s	
Adjustment inaccuracy	Typ. 10 V	
Voltage measurement error	0.5 % of meas. / ± 3 digit	
<b>Voltage measurement ranges</b>		
Measurement range 1 / resolution	500 µA / 1 µA	
Measurement range 2 / resolution	5.00 mA / 10 µA	
Current measurement error	0.5 % of meas. / ± 3 digit	
<b>Insulation resistance measurement<sup>1</sup></b>		
Test voltage DC	0.05 .. 6.00 kV	
Measurement range 1 / resolution	0.1 .. 2.50 MΩ / 10 kΩ	
Measurement range 2 / resolution	1 .. 25.0 MΩ / 100 kΩ	
Measurement range 3 / resolution	1 .. 50 MΩ / 1 MΩ	
Accuracy of measurement	2 % of meas. / ± 5 digit	
<b>Important technical data</b>		
Nominal capacity	30 W	
Short-circuit current	< 12 mA	
Mains connection	230 V / ± 10 %; 49 .. 61 Hz	
Dimensions	19" / 4 HU; Depth 360 mm	
Weight	15 kg	14 kg
Allowable humidity	25 .. 75 % rel.	
Working temperature	10 .. 50 °C	
Test time	0.5 .. 999.9 s	
Memory	min. 200 data sets	



Flexibility is of prime importance with Elabo. That is why two versions of the devices in this line of equipment are available. Depending on the purpose, universal use or fully automated operation are possible.

● Standard ○ Optional

<sup>1</sup> Extension module required

Technical specifications subject to change without notice.



<b>Technical data</b>	<b>G1-1B / G1-1N</b>
Test voltage:	0.05 .. 6.00 kV
Output:	12 W
Tripping current:	0 .. 20.0 µA • 0 .. 200 µA • 0 .. 2.00 mA
Interface:	Ethernet • digital interface 1
Line voltage:	230 V / ± 10%; 49 .. 61 Hz
Dimensions:	19" / 4 HU; depth 360 mm
Weight:	15 kg / 14 kg

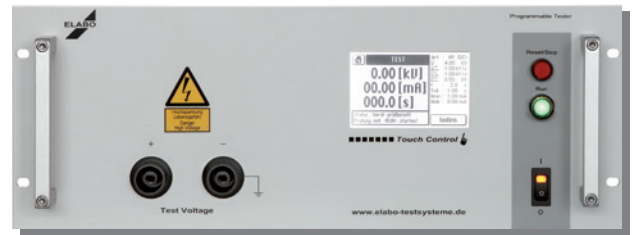

Front view G1-1B

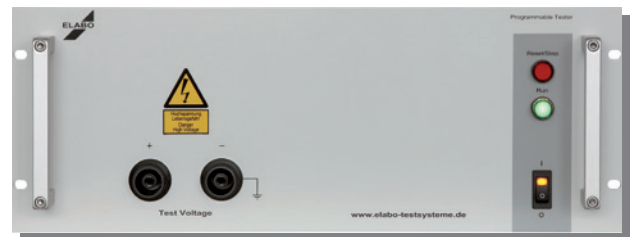

Front view G1-1N



Rear view G1-1B, G1-1N

### High-voltage testing device direct current (DC)

The testing device, which is available also as an automatic device, allows flexible possibilities for use in manual and automated systems – for high-voltage testing and optionally for measurement of insulation resistance in systems, assemblies and components. With its high test current resolution and wide measuring range for insulation resistance measurement, the unit is suitable for highly precise measurements in material investigations and also for insulation resistance measurement in the solar industry, for instance. For more detailed technical data, please see the table on back.

	Description	Dimensions	Item no.
High-voltage testing device DC	incl. touch control unit	19" / 4 HU	G1-1B
High-voltage testing device DC	for use in automated systems	19" / 4 HU	G1-1N

### Extension modules for the testing devices

	Technical data	for device type	Item no.
Insulation resistance measurement	Measurement range 5.00 / 50.0 / 500 MΩ / 5.00 GΩ	G1-1B; G1-1N	G1-1B E02
Voltage readback	The module allows four-wire measurement by reading back the test voltage. Two high-voltage receptacles are also built into the back wall of the device	G1-1B; G1-1N	G1-1B E04
Additional digital outputs	Six additional digital outputs for controlling an external switching matrix	G1-1B; G1-1N	G1-1B E06
RS232-C	Alternative interface to Ethernet interface	G1-1B; G1-1N	G1-1B E11
USB	Alternative interface to Ethernet interface	G1-1B; G1-1N	G1-1B E12
Software package	ElutionDevice software package	G1-1B; G1-1N	N2-1A Z7A
Device driver	On request		
Calibration	Delivery with Elabo works calibration protocol	G1-1B; G1-1N	G1-1B E99
Calibration	Delivery with Elabo works calibration protocol when the "insulation resistance measurement" extension function is integrated	G1-1B; G1-1N	G1-1B E99-02

The description of the accessories can be found starting on page 108. Please also see our sample configurations starting on page 34. Technical specifications subject to change without notice.

Device	G1-1B	G1-1N
<b>Applications</b>		
Manual use	●	
Automated use	●	●
<b>Operation</b>		
Touch display 4.3"	●	
<b>Interface</b>		
Start button	●	●
Reset button	●	●
<b>Interfaces</b>		
Ethernet	●	●
RS232-C	○	○
USB	○	○
Digital interface 1	●	●
Digital interface 2	○	○
2 Safety circuits	●	●
D/A Extension module	○	○
<b>Connections</b>		
Test probes front and back	●	●
Warning light connection at back	●	●
IEC connector at back	●	●
<b>Tests</b>		
High-voltage AC		
High-voltage DC	●	●
Insulation resistance measurement	○	○
Voltage readback	○	○
<b>Test voltages</b>		
Test voltage 1	0.05 .. 6.00 kV	
Residual ripple DC	< 0.01 %	
Adjusting speed ramp	0 .. 1 kV/s	
Adjustment inaccuracy	Typ. 5V	
Voltage measurement error	0.5 % of meas. / ± 3 digit	
<b>Voltage measurement ranges</b>		
Measurement range 1 / resolution	20.0 µA / 0.1 µA	
Measurement range 2 / resolution	200 µA / 1 µA	
Measurement range 3 / resolution	2.00 mA / 10 µA	
Current measurement error	0.5 % of meas. / ± 3 digit	
<b>Insulation resistance measurement<sup>1</sup></b>		
Test voltage DC	0.05 .. 6.00 kV	
Measurement range 1 / resolution	0.1 .. 5.00 MΩ / 10 kΩ	
Measurement range 2 / resolution	1 .. 50.0 MΩ / 100 kΩ	
Measurement range 3 / resolution	10 .. 500 MΩ / 1 MΩ	
Measurement range 4 / resolution	0.1 .. 5.00 GΩ / 10 MΩ	
Accuracy of measurement	1 % of meas. / ± 3 digit	
<b>Important technical data</b>		
Nominal capacity	12 W	
Short-circuit current	< 3 mA	
Mains connection	230 V / ± 10 %; 49 .. 61 Hz	
Dimensions	19" / 4 HU; depth 360 mm	
Weight	15 kg	14 kg
Allowable humidity	25 .. 75 % rel.	
Working temperature	10 .. 50 °C	
Test time	0.5 .. 999.9 s	
Memory	min. 200 data sets	



Flexibility is of prime importance with Elabo. That is why two versions of the devices in this line of equipment are available. Depending on the purpose, universal use or fully automated operation are possible.

● Standard ○ Optional  
<sup>1</sup> Extension module required  
 Technical specifications subject to change without notice.





<b>Technical data</b>	<b>G1-1G / G1-1T</b>
Test voltage:	0.1 .. 2.50 kV • 0.2 .. 5.00 kV
Output:	500 VA
Tripping current:	0 .. 10.00 mA • 100.0 mA
Interface:	Ethernet • digital interface 1
Line voltage:	230 V / ± 10%; 49 .. 61 Hz
Dimensions:	19" / 4 HU; depth 360 mm
Weight:	21 kg / 20 kg

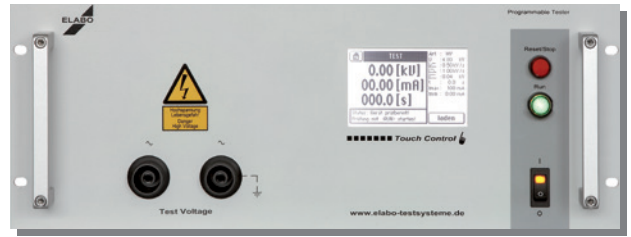

Front view G1-1G



Front view G1-1T

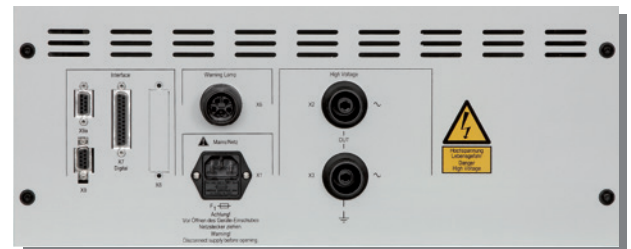

Rear view G1-1G, G1-1T

**High-voltage testing device alternating current (AC)**

The testing device, which is also available as an automatic device, allows flexible possibilities for use in manual and automated systems – for high-voltage testing of systems, assemblies and components. For more detailed technical data, please see the table on back.

	Description	Dimensions	Item no.
High-voltage testing device AC	incl. touch control unit	19" / 4 HU	G1-1G
High-voltage testing device AC	for use in automated systems	19" / 4 HU	G1-1T

**Extension modules for the testing devices**

	Technical data	for device type	Item no.
Passive current limitation	< 3 mA at U= 5.00 kV	G1-1G; G1-1T	G1-1G E03
Burn function	Over-current tripping can be deactivated for troubleshooting	G1-1G; G1-1T	G1-1G E05
Additional digital outputs	Six additional digital outputs for controlling an external switching matrix	G1-1G; G1-1T	G1-1G E06
RS232-C	Alternative interface to Ethernet interface	G1-1G; G1-1T	G1-1G E11
USB	Alternative interface to Ethernet interface	G1-1G; G1-1T	G1-1G E12
Software package	ElutionDevice software package	G1-1G; G1-1T	N2-1A Z7A
Device driver	On request		
Calibration	Delivery with Elabo works calibration protocol	G1-1G; G1-1T	G1-1G E99

The description of the accessories can be found starting on page 108. Please also see our sample configurations starting on page 34. Technical specifications subject to change without notice.

Device	G1-1G	G1-1T
<b>Applications</b>		
Manual use	●	
Automated use	●	●
<b>Operation</b>		
Touch display 4.3"	●	
Interface	●	●
Start button	●	
Reset button	●	●
<b>Interfaces</b>		
Ethernet	●	●
RS232-C	○	○
USB	○	○
Digital interface 1	●	●
Digital interface 2	○	○
2 Safety circuits	●	●
D/A Extension module	○	○
<b>Connections</b>		
Test probes front and back	●	●
Warning light connection at back	●	●
IEC connector at back	●	●
<b>Tests</b>		
High-voltage AC	●	●
Passive safety current limitation <sup>1</sup>	○	○
Burn function <sup>1</sup>	○	○
<b>Test voltages</b>		
Test voltage 1	0.1 .. 2.50 kV	
Test voltage 2	0.2 .. 5.00 kV	
Adjusting speed ramp	0 .. 3.5 kV/s	
Adjustment inaccuracy	Typ. 10V	
Voltage measurement error	1 % of meas. / ± 3 digit	
<b>Voltage measurement ranges</b>		
Measurement range 1 / resolution	10.00 mA / 10 µA	
Measurement range 2 / resolution	100.0 mA / 100 µA	
Current measurement error	1 % of meas. / ± 3 digit	
<b>Important technical data</b>		
Nominal capacity	500 VA	
Short-circuit current	> 200 mA	
Mains connection	230V / ± 10 %; 49 .. 61 Hz	
Dimensions	19" / 4 HU; Depth 360 mm	
Weight	21 kg	20 kg
Allowable humidity	25 .. 75 % rel.	
Working temperature	10 .. 50 °C	
Test time	0.5 .. 999.9 s	
Memory	min. 200 data sets	



Flexibility is of prime importance with Elabo. That is why two versions of the devices in this line of equipment are available. Depending on the purpose, universal use or fully automated operation are possible.

● Standard ○ Optional

<sup>1</sup> cannot be combined

Technical specifications subject to change without notice.

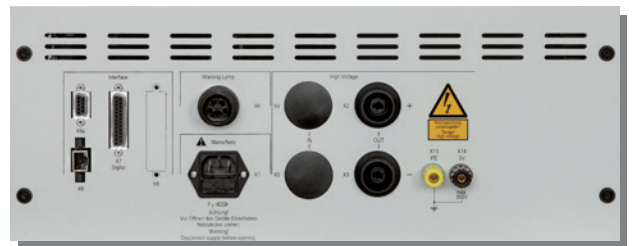
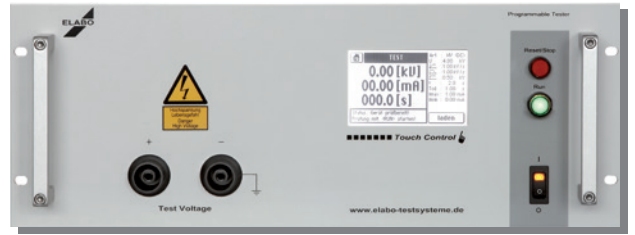
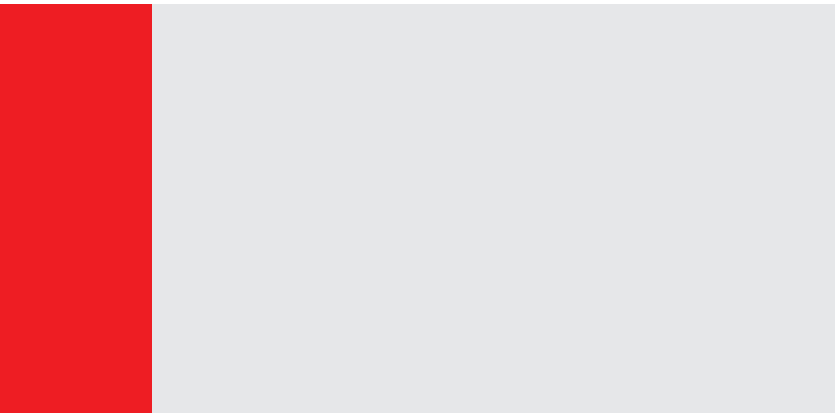

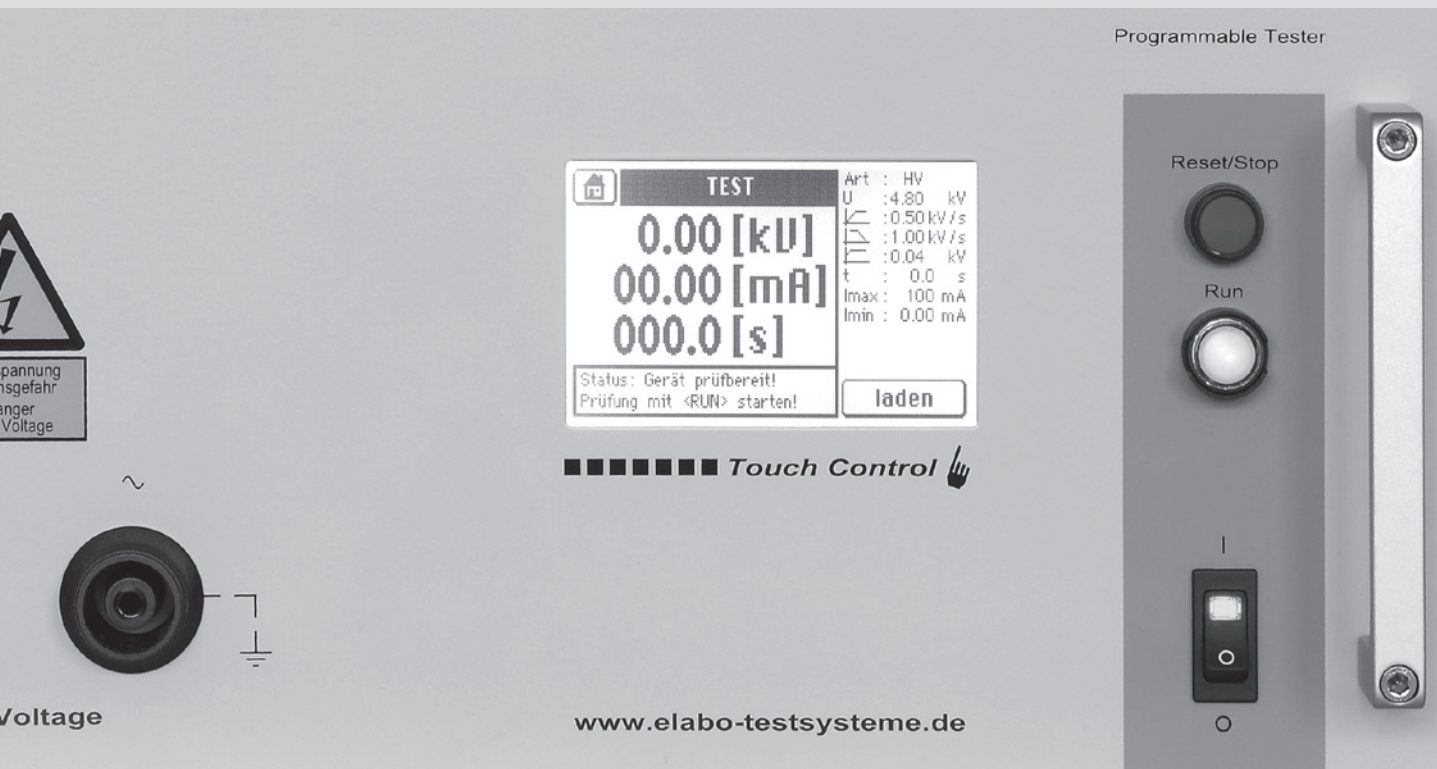

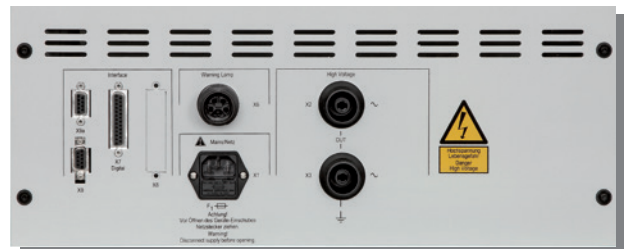
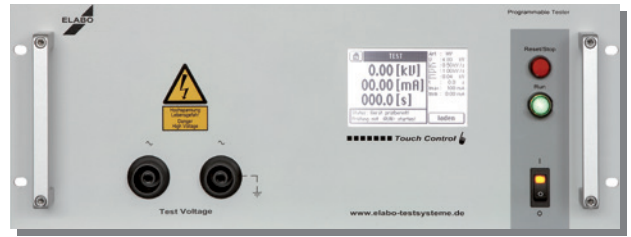
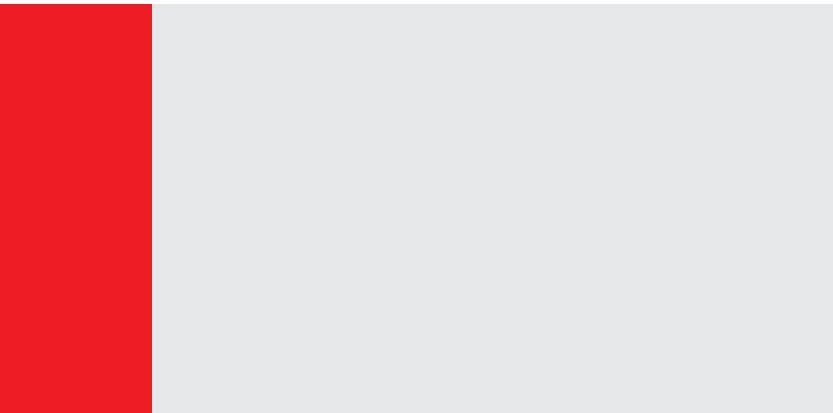

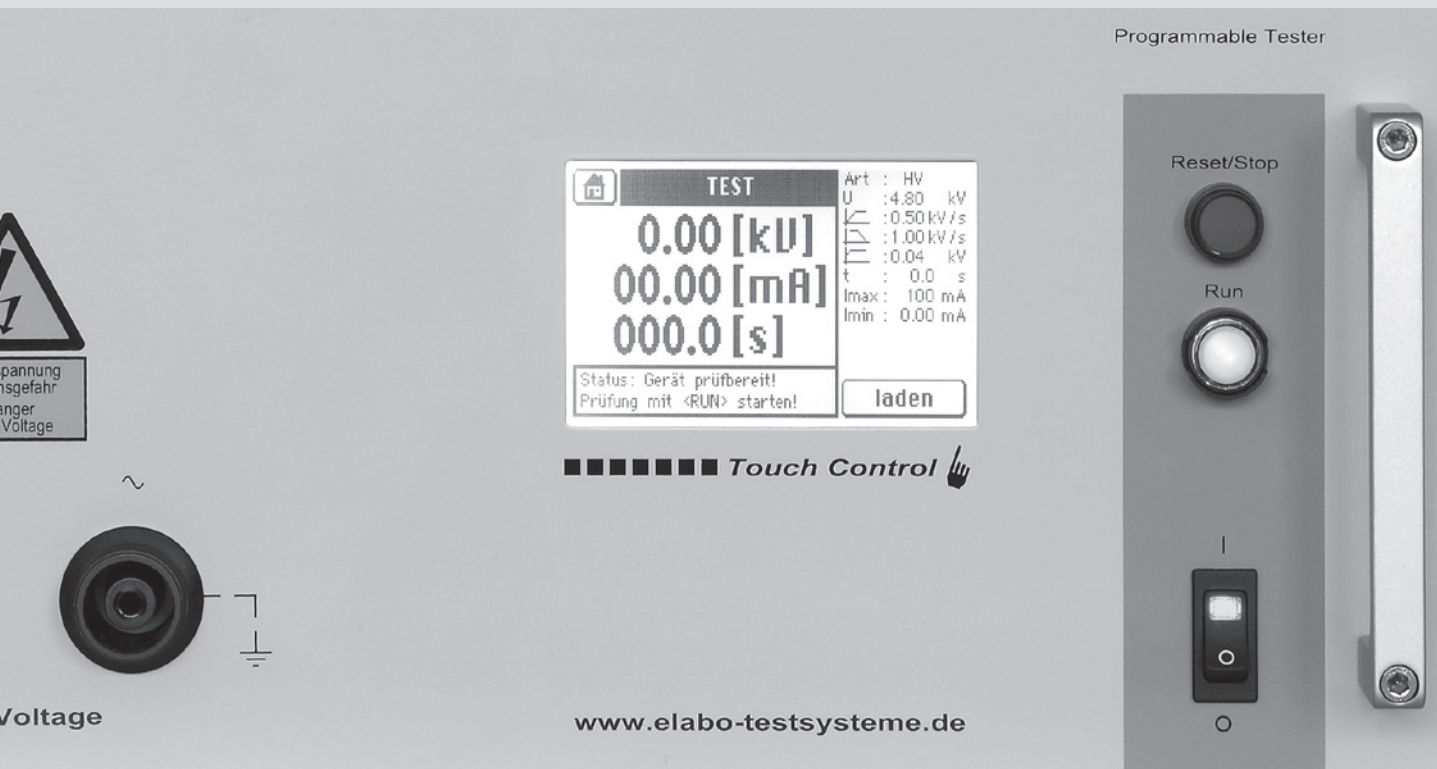



Technical data	<b>F1-1A / F1-1M</b>
Test voltage:	100 .. 2.500 VAC 200 .. 5.000 VAC 200 .. 3.500 VDC (option) 300 .. 6.000 VDC (option)
Nominal power:	500 VA
Tripping current:	0 .. 1 / 10 / 100 mA
Interface:	RS232-C
Mains voltage:	230 V / ±10% / 49 .. 51 Hz*
Size:	19" / 4 HU
Weight:	approx. 22 kg



Front view F1-1A



Front view F1-1M



Rear view F1-1A, F1-1M

**Modular high-voltage testing device**

Depending on the version and extension status, the devices provide flexible deployment possibilities during manual and automated use for high-voltage and insulation resistance testing on systems, subassemblies or components. For more detailed technical data, please see the table on back.

	Description	Size	Article no.
High-voltage test device	incl. TouchMe control unit	19" / 4 HU	F1-1A
High-voltage test device	for automatic use	19" / 4 HU	F1-1M

**Extension modules for the test devices**

	Technical data	For device type	Article no.
DC voltage	Test voltage: 200 .. 3.000 / 6.000 VDC Tripping current: 0 .. 1 / 10 / 100 mA	F1-1A, F1-1M	F1-1A E01
Insulation resistance	0.1 .. 1 / 10 / 35 MΩ + Autorange	F1-1A, F1-1M	F1-1A E02
Security current limitation	< 3 mA for AC; < 5 mA for DC	F1-1A, F1-1M	F1-1A E03
Voltage readback	The module allows a four-wire measurement by readback of the test voltage. Two high-voltage sockets are additionally incorporated in the back panel of the device.	F1-1A, F1-1M	F1-1A E04
Burn-Mode	Overvoltage tripping can be deactivated for troubleshooting.	F1-1A, F1-1M	F1-1A E05
Digital additional outputs	Six additional digital outputs for activation of an external switching matrix.	F1-1A, F1-1M	F1-1A E06
Ethernet	Alternative interface to RS232-C	F1-1A, F1-1M	F1-1A E10
USB	Alternative interface to RS232-C	F1-1A, F1-1M	F1-1A E12
Software package	ElutionDevice software package	F1-1A, F1-1M	N2-1A Z7D
Device driver	On request		
Calibration	Supplied with Elabo works calibration protocol	F1-1A, F1-1M	F1-1A E99

The description of the accessories can be found starting on page 108.

Please also see our sample configurations starting on page 36.

\*other mains frequency on request

Technical specifications subject to change without notice.

Device	F1-1A	F1-1M
<b>Application fields</b>		
Automatic use	●	●
Manual use	●	
<b>Operation</b>		
Touch Display 6.5"	●	
Interface	●	●
Start button	●	
Reset button	●	●
<b>Interfaces</b>		
RS 232-C	●	●
Ethernet	○	○
USB	○	○
USB accessory interface	●	
Digital interface 1	●	●
Digital interface 2	○	○
2 safety circuits	●	●
<b>Connections</b>		
HV test probes, rear	●	●
HV test probes, front	●	●
Warning lights	●	●
Non-heating apparatus socket	●	●
<b>Test functions</b>		
High voltage AC	●	●
High voltage DC	○	○
Insulation resistance measurement	○	○
Current limitation (EN50191) <sup>1</sup>	○	○
Burn-Mode (deact. tripping) <sup>1</sup>	○	○
Voltage readback	○	○
<b>Test voltages</b>		
Test voltage AC 1	100 .. 2.500 V	
Test voltage AC 2	200 .. 5.000 V	
Test voltage DC 1 <sup>2</sup>	200 .. 3.000 V	
Test voltage DC 2 <sup>2</sup>	300 .. 6.000 V	
Residual ripple DC <sup>2</sup>	< 3 % bei R > 3MΩ	
Positioning rate for ramp	10 .. 3.500 V/s	
Adjustment inaccuracy	Typ. 10 V	
Measurement error, voltage	0.5% of meas. ± 2 digit	
<b>Current ranges</b>		
Measurement range 1 / resolution	0 .. 100 mA / 100 µA	
Measurement range 2 / resolution	0 .. 10.0 mA / 10 µA	
Measurement range 3 / resolution	0 .. 1.000 mA / 1 µA	
Current tripping	Active current – Apparent current – Crest value – Delta I	
Accuracy Apparent current	measurement range 1	0.5 % of meas. +/- 2 digit
	measurement range 2	0.5 % of meas. +/- 5 digit
	measurement range 3	0.5 % of meas. +/- 20 digit
Accuracy Peak value	measurement range 1	1.0 % of meas. +/- 5 digit
	measurement range 2	1.0 % of meas. +/- 5 digit
	measurement range 3	1.0 % of meas. +/- 20 digit
Accuracy Active current	measurement range 1	1.0 % of meas. +/- 8 digit
	measurement range 2	1.0 % of meas. +/- 8 digit
	measurement range 3	1.0 % of meas. +/- 20 digit
Accuracy DC	measurement range 1 <sup>2</sup>	0.5 % of meas. +/- 2 digit
	measurement range 2 <sup>2</sup>	0.5 % of meas. +/- 2 digit
	measurement range 3 <sup>2</sup>	0.5 % of meas. +/- 2 digit
<b>Insulation resistance measurement<sup>2</sup></b>		
Test voltage DC 1	200 .. 3.000 V	
Test voltage DC 2	300 .. 6.000 V	
Measurement range 1	0.1 .. 1.00 MΩ	
Measurement range 2	1 .. 10.0 MΩ	
Measurement range 3	10 .. 35 MΩ	
Autorange	0.1 .. 35 MΩ	
Accuracy at 500 V	3% of meas. ± 1 digit	
Accuracy at 1.000 V	1% of meas. ± 1 digit	



Flexibility is of prime importance with Elabo. That is why two versions of the devices in this line of equipment are available. Depending on the purpose, universal use or fully automated operation are possible.

**Technical main data**

Nominal power	500 VA
Short-circuit current	>200 mA
Mains voltage	230 V +/- 10%
Mains frequency	49 .. 51 Hz*
Dimensions Depth 360 mm	19" / 4 HU
Weight	22 kg   21 kg
Permissible relative humidity	25 .. 75 % rel.
Operating temperature	10 .. 50 °C
Test time	0.1 .. 999.9 sec. / constant testing
Burn-Mode current <sup>2</sup>	approx. 200 mA
Feedback threshold <sup>2</sup>	0.7 .. 1 x U <sub>test</sub>

- Standard ○ Optional

<sup>1</sup> cannot be combined

<sup>2</sup> Extension module required

\*other mains frequency on request

Technical specifications subject to change without notice.





Technical data	<b>F1-1B / F1-1N</b>
Test voltage:	200 .. 3.500 VAC 300 .. 7.000 VAC 300 .. 4.500 VDC (option) 400 .. 9.000 VDC (option)
Nominal power:	500 VA
Tripping current:	0 .. 1 / 10 / 70 mA
Interface:	RS232-C
Mains voltage:	230 V / ±10% / 49 .. 51 Hz*
Size:	19" / 4 HU
Weight:	approx. 23 kg

**Modular high-voltage testing device**

Device versions with different output voltages are available depending on the application. The optional extension modules allow individual configuration of your system. For more detailed technical data, please see the table on back.



Front view F1-1B



Front view F1-1N



Rear view F1-1B, F1-1N

	Description	Size	Article no.
High-voltage test device	incl. TouchMe control unit	19" / 4 HU	F1-1B
High-voltage test device	for automatic use	19" / 4 HU	F1-1N

**Extension modules for the test devices**

	Technical data	For device type	Article no.
DC voltage	Test voltage: 300 .. 4.500 / 9.000 VDC Tripping current: 0 .. 1 / 10 / 70 mA	F1-1B, F1-1N	F1-1B E01
Insulation resistance	0.1 .. 1 / 10 / 35 MΩ + Autorange	F1-1B, F1-1N	F1-1B E02
Security current limitation	< 3 mA for AC; < 5 mA for DC	F1-1B, F1-1N	F1-1B E03
Voltage readback	The module allows a four-wire measurement by read-back of the test voltage. Two high-voltage sockets are additionally incorporated in the back panel of the device.	F1-1B, F1-1N	F1-1B E04
Burn-Mode	Overvoltage tripping can be deactivated for troubleshooting.	F1-1B, F1-1N	F1-1B E05
Digital additional outputs	Six additional digital outputs for activation of an external switching matrix.	F1-1B, F1-1N	F1-1B E06
Ethernet	Alternative interface to RS232-C	F1-1B, F1-1N	F1-1B E10
USB	Alternative interface to RS232-C	F1-1B, F1-1N	F1-1B E12
Software package	ElutionDevice software package	F1-1B, F1-1N	N2-1A Z7D
Device driver	On request		
Calibration	Supplied with Elabo works calibration protocol	F1-1B, F1-1N	F1-1B E99

The description of the accessories can be found starting on page 108.

Please also see our sample configurations starting on page 36.

\*other mains frequency on request

Technical specifications subject to change without notice.

Device	F1-1B	F1-1N
<b>Application fields</b>		
Automatic use	●	●
Manual use	●	
<b>Operation</b>		
Touch Display 6.5"	●	
Interface	●	●
Start button	●	
Reset button	●	●
<b>Interfaces</b>		
RS 232-C	●	●
Ethernet	○	○
USB	○	○
USB accessory interface	●	
Digital interface 1	●	●
Digital interface 2	○	○
2 safety circuits	●	●
<b>Connections</b>		
HV test probes, rear	●	●
HV test probes, front	●	●
Warning lights	●	●
Non-heating apparatus socket	●	●
<b>Test functions</b>		
High voltage AC	●	●
High voltage DC	○	○
Insulation resistance measurement	○	○
Current limitation (EN50191) <sup>1</sup>	○	○
Burn-Mode (deact. tripping) <sup>1</sup>	○	○
Voltage readback	○	○
<b>Test voltages</b>		
Test voltage AC 1	200 .. 3.500 V	
Test voltage AC 2	300 .. 7.000 V	
Test voltage DC 1 <sup>2</sup>	300 .. 4.500 V	
Test voltage DC 2 <sup>2</sup>	400 .. 9.000 V	
Residual ripple DC <sup>2</sup>	< 3 % bei R > 3 MΩ	
Positioning rate for ramp	10 .. 3.500 V/s	
Adjustment inaccuracy	Typ. 15 V	
Measurement error, voltage	1% of meas. ± 2 digit	
<b>Current ranges</b>		
Measurement range 1 / resolution	0 .. 70 mA / 100 μA	
Measurement range 2 / resolution	0 .. 10.0 mA / 10 μA	
Measurement range 3 / resolution	0 .. 1.000 mA / 1 μA	
Current tripping	Active current – Apparent current – Crest value – Delta I	
Accuracy	measurement range 1	0.5 % of meas. +/- 2 digit
	measurement range 2	0.5 % of meas. +/- 5 digit
	measurement range 3	0.5 % of meas. +/- 20 digit
Apparent current	measurement range 1	1.0 % of meas. +/- 5 digit
	measurement range 2	1.0 % of meas. +/- 5 digit
	measurement range 3	1.0 % of meas. +/- 20 digit
Accuracy Peak value	measurement range 1	1.0 % of meas. +/- 8 digit
	measurement range 2	1.0 % of meas. +/- 8 digit
	measurement range 3	1.0 % of meas. +/- 20 digit
Active current	measurement range 1	0.5 % of meas. +/- 2 digit
	measurement range 2	0.5 % of meas. +/- 2 digit
	measurement range 3 <sup>2</sup>	0.5 % of meas. +/- 2 digit
DC	measurement range 1 <sup>2</sup>	0.5 % of meas. +/- 2 digit
	measurement range 2 <sup>2</sup>	0.5 % of meas. +/- 2 digit
	measurement range 3 <sup>2</sup>	0.5 % of meas. +/- 2 digit
<b>Insulation resistance measurement<sup>2</sup></b>		
Test voltage DC 1	300 .. 4.500 V	
Test voltage DC 2	400 .. 9.000 V	
Measurement range 1	0.1 .. 1.00 MΩ	
Measurement range 2	1 .. 10.0 MΩ	
Measurement range 3	10 .. 35 MΩ	
Autorange	0.1 .. 35 MΩ	
Accuracy at 500 V	3% of meas. ± 1 digit	
Accuracy at 1.000 V	1% of meas. ± 1 digit	



Flexibility is of prime importance with Elabo. That is why two versions of the devices in this line of equipment are available. Depending on the purpose, universal use or fully automated operation are possible.

**Technical main data**

Nominal power	500 VA
Short-circuit current	>140 mA
Mains voltage	230 V +/- 10%
Mains frequency	49 .. 51 Hz*
Dimensions    Depth 360 mm	19" / 4 HU
Weight	23 kg    22 kg
Permissible relative humidity	25 .. 75 % rel.
Operating temperature	10 .. 50 °C
Test time	0.1 .. 999.9 s constant testing
Burn-Mode current <sup>2</sup>	ca. 140 mA
Feedback threshold <sup>2</sup>	0.7 .. 1 x U <sub>test</sub>

● Standard    ○ Optional

<sup>1</sup> cannot be combined

<sup>2</sup> Extension module required

\*other mains frequency on request

Technical specifications subject to change without notice.



Technical data	<b>F1-1C / F1-1P</b>
Test voltage:	300 .. 5.000 VAC 400 .. 10.000 VAC 400 .. 6.000 VDC (option) 500 .. 12.000 VDC (option)
Nominal power:	500 VA
Tripping current:	0 .. 1 / 10 / 50 mA
Interface:	RS232-C
Mains voltage:	230 V / ±10% / 49 .. 51 Hz*
Size:	19" / 6 HU
Weight:	approx. 28 kg

**Modular high-voltage testing device**

Depending on the version and extension status, the devices provide flexible deployment possibilities during manual and automated use for high-voltage and insulation resistance testing on systems, subassemblies or components. For more detailed technical data, please see the table on back.



Front view F1-1C

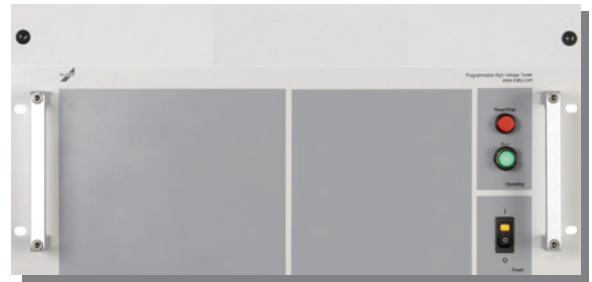

Front view F1-1P



Rear view F1-1C, F1-1P

	Description	Size	Article no.
High-voltage test device	incl. TouchMe control unit	19" / 6 HU	F1-1C
High-voltage test device	for automatic use	19" / 6 HU	F1-1P

**Extension modules for the test devices**

	Technical data	For device type	Article no.
DC voltage	Test voltage: 400 .. 6.000 / 12.000 VDC Tripping current: 0 .. 1 / 10 / 50 mA	F1-1C, F1-1P	F1-1C E01
Insulation resistance	0.1 .. 1 / 10 / 35 MΩ + Autorange	F1-1C, F1-1P	F1-1C E02
Digital additional outputs	Six additional digital outputs for activation of an external switching matrix.	F1-1C, F1-1P	F1-1C E06
Ethernet	Alternative interface to RS232-C	F1-1C, F1-1P	F1-1C E10
USB	Alternative interface to RS232-C	F1-1C, F1-1P	F1-1C E12
Software package	ElutionDevice software package	F1-1C, F1-1P	N2-1A Z7D
Device driver	On request		
Calibration	Supplied with Elabo works calibration protocol	F1-1C, F1-1P	F1-1C E99

The description of the accessories can be found starting on page 108.

Please also see our sample configurations starting on page 36.

\*other mains frequency on request

Technical specifications subject to change without notice.

Device	F1-1C	F1-1P
<b>Application fields</b>		
Automatic use	●	●
Manual use	●	
<b>Operation</b>		
Touch Display 6.5"	●	
Interface	●	●
Start button	●	
Reset button	●	●
<b>Interfaces</b>		
RS 232-C	●	●
Ethernet	○	○
USB	○	○
USB accessory interface	●	
Digital interface 1	●	●
Digital interface 2	○	○
2 safety circuits	●	●
<b>Connections</b>		
HV test probes, rear	●	●
HV test probes, front		
Warning lights	●	●
Non-heating apparatus socket	●	●
<b>Test functions</b>		
High voltage AC	●	●
High voltage DC	○	○
Insulation resistance measurement	○	○
<b>Test voltages</b>		
Test voltage AC 1	300 .. 5.000 V	
Test voltage AC 2	400 .. 10.000 V	
Test voltage DC 1 <sup>1</sup>	400 .. 6.000 V	
Test voltage DC 2 <sup>1</sup>	500 .. 12.000 V	
Residual ripple DC <sup>1</sup>	< 3 % with R > 3 MΩ	
Positioning rate for ramp	10 .. 3.500 V/s	
Adjustment inaccuracy	Typ. 20 V	
Measurement error, voltage	1% of meas. ± 2 digit	
<b>Current ranges</b>		
Measurement range 1 / resolution	0 .. 50 mA / 100 μA	
Measurement range 2 / resolution	0 .. 10.0 mA / 10 μA	
Measurement range 3 / resolution	0 .. 1.000 mA/ 1 μA	
Current tripping	Active current – Apparent current – Crest value – Delta I	
Accuracy Apparent current	measurement range 1	0.5 % of meas. +/- 2 digit
	measurement range 2	0.5 % of meas. +/- 5 digit
	measurement range 3	0.5 % of meas. +/- 20 digit
Accuracy Peak value	measurement range 1	1.0 % of meas. +/- 5 digit
	measurement range 2	1.0 % of meas. +/- 5 digit
	measurement range 3	1.0 % of meas. +/- 20 digit
Accuracy Active current	measurement range 1	1.0 % of meas. +/- 16 digit
	measurement range 2	1.0 % of meas. +/- 16 digit
	measurement range 3	1.0 % of meas. +/- 40 digit
Accuracy DC	measurement range 1 <sup>1</sup>	0.5 % of meas. +/- 2 digit
	measurement range 2 <sup>1</sup>	0.5 % of meas. +/- 2 digit
	measurement range 3 <sup>1</sup>	0.5 % of meas. +/- 2 digit
<b>Insulation resistance measurement<sup>1</sup></b>		
Test voltage DC 1	400 .. 6.000 V	
Test voltage DC 2	500 .. 12.000 V	
Measurement range 1	0.1 .. 1.00 MΩ	
Measurement range 2	1 .. 10.0 MΩ	
Measurement range 3	10 .. 35 MΩ	
Autorange	0.1 .. 35 MΩ	
Accuracy at 500 V	3% of meas. ± 1 digit	
Accuracy at 1.000 V	1% of meas. ± 1 digit	



Flexibility is of prime importance with Elabo. That is why two versions of the devices in this line of equipment are available. Depending on the purpose, universal use or fully automated operation are possible.

**Technical main data**

Nominal power	500 VA	
Short-circuit current	>100 mA	
Mains voltage	230 V +/- 10%	
Mains frequency	49 .. 51 Hz*	
Dimensions	Depth 360 mm	19" / 6 HU
Weight	27 kg	26 kg
Permissible relative humidity	25 .. 75 % rel.	
Operating temperature	10 .. 50 °C	
Test time	0.1 .. 999.9 sec. / constant testing	
Burn-Mode current <sup>1</sup>	approx. 100 mA	
Feedback threshold <sup>1</sup>	0.7 .. 1 x U <sub>Test</sub>	

● Standard ○ Optional  
<sup>1</sup> Extension module required  
 \*other mains frequency on request  
 Technical specifications subject to change without notice.



<b>Technical data</b>	<b>F1-1D / F1-1Q</b>
<b>Test voltage:</b>	400 .. 6.000 VAC 500 .. 12.000 VAC 500 .. 8.000 VDC (option) 600 .. 16.000 VDC (option)
<b>Nominal power:</b>	500 VA
<b>Tripping current:</b>	0 .. 1 / 10 / 40 mA
<b>Interface:</b>	RS232-C
<b>Mains voltage:</b>	230 V / ±10% / 49 .. 51 Hz*
<b>Size:</b>	19" / 10 HU
<b>Weight:</b>	approx. 30 kg

**Modular high-voltage testing device**

Depending on the version and extension status, the devices provide flexible deployment possibilities during manual and automated use for high-voltage and insulation resistance testing on systems, subassemblies or components. For more detailed technical data, please see the table on back.

Front view F1-1D



Front view F1-1Q



Rear view F1-1D, F1-1Q



	Description	Size	Article no.
High-voltage test device	incl. TouchMe control unit	19" / 10 HU	F1-1D
High-voltage test device	for automatic use	19" / 10 HU	F1-1Q

**Extension modules for the test devices**

	Technical data	For device type	Article no.
DC voltage	Test voltage: 500 .. 8.000 / 16.000 VDC Tripping current: 0 .. 1 / 10 / 40 mA	F1-1D, F1-1Q	F1-1D E01
Insulation resistance	0.1 .. 1 / 10 / 35 MΩ + Autorange	F1-1D, F1-1Q	F1-1D E02
Digital additional outputs	Six additional digital outputs for activation of an external switching matrix.	F1-1D, F1-1Q	F1-1C E06
Ethernet	Alternative interface to RS232-C	F1-1D, F1-1Q	F1-1D E10
USB	Alternative interface to RS232-C	F1-1D, F1-1Q	F1-1D E12
Software package	ElutionDevice software package	F1-1D, F1-1Q	N2-1A Z7D
Device driver	On request		
Calibration	Supplied with Elabo works calibration protocol	F1-1D, F1-1Q	F1-1D E99

The description of the accessories can be found starting on page 108. Please also see our sample configurations starting on page 36.

\*other mains frequency on request

Technical specifications subject to change without notice.

Device	F1-1D	F1-1Q
<b>Application fields</b>		
Automatic use	●	●
Manual use	●	
<b>Operation</b>		
Touch Display 6.5"	●	
Interface	●	●
Start button	●	
Reset button	●	●
<b>Interfaces</b>		
RS 232-C	●	●
Ethernet	○	○
USB	○	○
USB accessory interface	●	
Digital interface 1	●	●
Digital interface 2	○	○
2 safety circuits	●	●
<b>Connections</b>		
HV test probes, rear	●	●
Warning lights	●	●
Non-heating apparatus socket	●	●
<b>Test functions</b>		
High voltage AC	●	●
High voltage DC	○	○
Insulation resistance measurement	○	○
<b>Test voltages</b>		
Test voltage AC 1	400 .. 6.000 V	
Test voltage AC 2	500 .. 12.000 V	
Test voltage DC 1 <sup>1</sup>	500 .. 8.000 V	
Test voltage DC 2 <sup>1</sup>	600 .. 16.000 V	
Residual ripple DC <sup>1</sup>	< 3 % with R > 3 MΩ	
Positioning rate for ramp	10 .. 3.500 V/s	
Adjustment inaccuracy	Typ. 30 V	
Measurement error, voltage	1% of meas. ± 3 digit	
<b>Current ranges</b>		
Measurement range 1 / resolution	0 .. 40 mA / 100 μA	
Measurement range 2 / resolution	0 .. 10.0 mA / 10 μA	
Measurement range 3 / resolution	0 .. 1.000 mA / 1 μA	
<b>Current tripping</b>		Active current – Apparent current – Crest value – Delta I
Accuracy	measurement range 1	0.5 % of meas. +/- 2 digit
	measurement range 2	0.5 % of meas. +/- 5 digit
Apparent current	measurement range 3	0.5 % of meas. +/- 20 digit
	measurement range 1	1.0 % of meas. +/- 5 digit
Accuracy Peak value	measurement range 2	1.0 % of meas. +/- 5 digit
	measurement range 3	1.0 % of meas. +/- 20 digit
Accuracy Active current	measurement range 1	1.0 % of meas. +/- 16 digit
	measurement range 2	1.0 % of meas. +/- 16 digit
DC	measurement range 3	1.0 % of meas. +/- 40 digit
	measurement range 1 <sup>1</sup>	0.5 % of meas. +/- 2 digit
Insulation resistance measurement <sup>1</sup>	measurement range 2 <sup>1</sup>	0.5 % of meas. +/- 2 digit
	measurement range 3 <sup>1</sup>	0.5 % of meas. +/- 2 digit
Test voltage DC 1	500 .. 8.000 V	
Test voltage DC 2	600 .. 16.000 V	
Measurement range 1	0.1 .. 1.00 MΩ	
Measurement range 2	1 .. 10.0 MΩ	
Measurement range 3	10 .. 35 MΩ	
Autorange	0.1 .. 35 MΩ	
Accuracy at 500 V	3% of meas. ± 1 digit	
Accuracy at 1.000 V	1% of meas. ± 1 digit	



Flexibility is of prime importance with Elabo. That is why two versions of the devices in this line of equipment are available. Depending on the purpose, universal use or fully automated operation are possible.

### Technical main data

Nominal power	500 VA	
Short-circuit current	>100 mA	
Mains voltage	230 V +/- 10%	
Mains frequency	49 .. 51 Hz*	
Dimensions	Depth 360 mm	19" / 10 HU
Weight	30 kg	29 kg
Permissible relative humidity	25 .. 75 % rel.	
Operating temperature	10 .. 50 °C	
Test time	0.1 .. 999.9 sec. / constant testing	
Burn-Mode current <sup>1</sup>	approx. 100 mA	
Feedback threshold <sup>1</sup>	0.7 .. 1 x U <sub>Test</sub>	

● Standard ○ Optional

<sup>1</sup> Extension module required

\*other mains frequency on request

Technical specifications subject to change without notice.

Elabo - with us  
always on the  
safe side!



# Optimum function in practice

Elabo testing devices – perfectly configured for your testing tasks

**Elabo** *BestPerformance*

**Requirement:**

Set up a DC high-voltage test station for manual testing. This example shows a typical configuration for this application. Device components and tailor-made accessories complement each other ideally.



Description	Quantity	Item no.
High-voltage testing device 6000 VDC	1	G1-1A
Housing	1	93-1B
Guiding rails	1	93-1F
Test probes	1	94-2A
Foot switch	1	F9-1D
Calibration	1	G1-1A E99



**Requirement:**

Integrate an AC high-voltage testing device in an automated system. For typical automated systems we offer our partners (OEM) tailor-made solutions. You can find additional useful components such as plug connectors and relays in our accessories program.

Description	Quantity	Item no.
High-voltage testing device 5000 VAC	1	G1-1T
Warning lights	1	F9-1A
Connection cable 2 m	1	94-2B
Calibration	1	G1-1G E99





**Requirement:**

Set up a mobile high-voltage test station for manual testing. Frequently the locations at which tests must be performed are not stationary. In addition to the test systems, the Elabo TaMo program offers a selection of flexibly configurable mobile units.

Description	Quantity	Item no.
High-voltage testing device 5000 VAC	1	G1-1G
Housing	1	93-1B
Guiding rails	1	93-1F
Test probes	1	94-2A
Foot switch	1	F9-1D
Warning lights	1	94-2C
Calibration	1	G1-1G E99
Mobile test unit	1	T0-1T Z10



You can order our current TaMo catalog directly by calling +49 7951 307-0.



**Requirement:**

Set up a high-voltage test station with inherent electric shock protection. Pluggable solutions can be created in combination with our test cages to maximize operator safety.

Description	Quantity	Item no.
High-voltage testing device 5000 VAC	1	G1-1G
Housing	1	93-1B
Guiding rails	1	93-1F
Test cage	1	94-3A

High-voltage testing devices from Elabo have long been in rigorous daily use. One reason: We support our customers consistently through all phases of the testing process. Starting with a needs determination, selection of the appropriate device and complementary accessories, through to the calibration of the entire system.

**Elabo – your partner for practical and complete solutions.**



# Optimum function in practice

Elabo test devices – perfectly configured for your test duties

## HighPerformance

**Requirement:**

Setup of a high voltage test bench for manual testing. This example shows a typical configuration for this application. Device components and accessories tailored to needs ideally complement each other.

Description	Number	Article no.
High-voltage test device	1	F1-1B
DC extension module	1	F1-1B E01
Housing	1	93-1B
Guide rails	1	93-1F
Test probes	1	94-2A
Foot switches	1	F9-1D
Warning lights	1	94-2C
Calibration	1	F1-1B E99



**Requirement:**

Setup of a mobile high-voltage test bench for manual testing. The sites at which tests need to be performed are often not stationary. In addition to the test systems, the Elabo-TaMo range includes a selection of flexibly configurable mobiles.

Description	Number	Article no.
High-voltage test device	1	F1-1A
DC extension module	1	F1-1A E01
Housing	1	93-1B
Guide rails	1	93-1F
Test probes	1	94-2A
Foot switch	1	F9-1D
Warning lights	1	94-2C
Calibration	1	F1-1A E99
Test mobile	1	T0-1T Z10



High-voltage testing devices from Elabo have been in demanding daily use for many years. One of the reasons is: we consistently support our customers throughout all stages of the test process. Starting with determination of requirements, selection of the appropriate device and supplementary accessories and extending to calibration of the entire system.

**Elabo – the partner for practical complete solutions**



**Requirement:**

Integration of a high-voltage testing device in an automatic system. We offer our partners (OEM) tailored solutions for typical automatic use. You will find other useful components such as plug connectors and relays in our range of accessories.

Description	Number	Article no.
High-voltage test device 5.000 VAC	1	F1-1M
High-voltage cable	1	94-2B
Warning lights	1	94-2C
Software	1	N2-1A Z7D
Calibration	1	F1-1A E99



**Requirement:**

Setup of a high-voltage test bench with compulsory protection against contact. In combination with our test chambers, ready-to-plug-in solutions can be produced that increase operating safety to a maximum.

Description	Number	Article no.
High-voltage test device	1	F1-1A
Housing	1	93-1B
Guide rails	1	93-1F
Test chamber	1	94-3A

# Combi-testers

Safety and function tests all from one mould

## Combi-testers

Providing proof of product safety requires that a number of various standards be fulfilled. In most cases these standards include the performance of several safety tests. As a rule both a protective earth conductor resistance measurement and a high-voltage test are required. Corresponding insulation resistance measurements are also often required. Elabo's product range is perfectly aligned with the various requirements and provides a broad spectrum of different devices and add-on modules. Elabo makes it possible – all requirements can be optimally fulfilled with one testing device.

Elabo – a guarantee of reproducible test systems that conform to standards and are always absolutely reliable.



### Measurement of PE conductor resistance

The principle of measuring PE conductor resistance in products in protection class 1 is simple to understand. A current is directed from a PELV current source (usually 6 or 12 VAC no-load voltage) from the PE connection to all exposed metal parts. The resistance is determined from the voltage drop and the flowing current. Typical threshold values are between 100 and 200 mΩ. However, other threshold values are also used depending on the product to be tested. Because of the low test voltage, no additional safety measures are necessary in the PE test.





### Insulation resistance measurement



Measurement of the insulation resistance assesses the actual effective resistance component of the insulation material. The test voltage is generally 500 V DC, and it is applied between active and inactive parts of the test object. Applicable threshold values are usually in the 1 .. 100 MΩ range.



### High-voltage testing



High-voltage testing serves to test for insulation strength and electric strength in devices, machines, components and insulation materials. During the testing process, voltage is applied to the devices being tested, and these voltages have no effect when the devices are operating properly. During high-voltage testing, changes to materials, such as deteriorating insulation properties, as well as manufacturing faults (e.g. loose terminals or damaged insulation) are detected. Additionally, the proper dimensioning of air gaps and creepage distances and the selection of appropriate insulation materials are verified. Common test voltages are in the range of 1000- 2500 V, but may in certain cases exceed 10000 V. High-voltage testing involves considerable risks for operating personnel. Observance of safety precautions, such as those described in EN 50191 (VDE0104), is therefore mandatory for the test procedure.



Elabo offers an extensive accessories program to ensure the safety of operators.

Whether as an individual workstation solution or as a partially or fully automated testing system, in the workshop, the laboratory or in mass production – Elabo testing devices stand out because of their broad, flexible range of applications. Right from the start, the base models of all test equipment are equipped for most applications and can also be adapted at a later date to modified or expanded requirements using appropriate add-on modules.





**Elabo – long-term reliable solutions in all cases.**

# Elabo **BestPerformance**



Device	G7-1A	G7-1M	G7-1B	G7-1N	G7-1G	G7-1T
Page	43	43	45	45	47	47

Application fields						
Manual use						
Automated use						

Measurement types						
High-voltage AC 						
High-voltage DC 						
Insulation resistance measurement 						
PE conductor resistance measurement 						

Extensions						
Integrated switching-field						
Current limitation (EN50191)						
Burn-Mode						
Voltage readback						

Flexibility is of prime importance with Elabo. That is why two versions of the devices in this line of equipment are available. Depending on the purpose, universal use or fully automated operation are possible.

# Elabo **High Performance**



F7-1A	F7-1M	F7-1B	F7-1N	F7-1C	F7-1P
49	49	51	51	53	53



- Standard
- Optional

Elabo - Perfect  
quality for your  
quality assurance!







<b>Technical data</b>	<b>G7-1A / G7-1M</b>
<b>High voltage:</b>	0.05 .. 6.00 kV • 0 .. 500 µA • 0 .. 5.00 mA
<b>Protective earth conductor:</b>	0 .. 500 mΩ • 12 VAC / > 10 A
<b>Insulation resistance:</b>	2.50 • 25.0 • 50 MΩ
<b>Output:</b>	30W
<b>Interface:</b>	Ethernet • digital interface 1
<b>Line voltage:</b>	230 V ± 10%; 49 .. 61 Hz
<b>Dimensions:</b>	19" / 4 HU; depth 360 mm
<b>Weight:</b>	25 kg • 24 kg

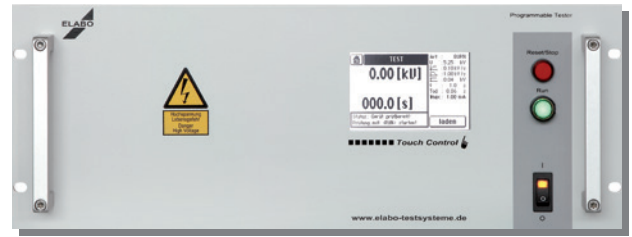

Front view G7-1A



Front view G7-1M

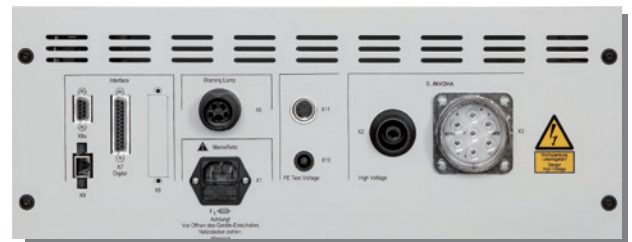

Rear view G7-1A, G7-1M

**Direct current combination testing device (HVDC)**

The testing device, which is also available as an automatic device, allows flexible possibilities for use in manual and automated systems for the measurement of protective earth conductor and insulation resistance as well as for high-voltage testing in systems, assemblies and components. Accessory components configurable especially for this model round out the system. For more detailed technical data, please see the table on back.

	Description	Dimensions	Item no.
HVDC combi-tester	incl. touch control unit and selector panel	19" / 4 HU	G7-1A
HVDC combi-tester	for use in automated systems, incl. selector panel	19" / 4 HU	G7-1M

**Extension modules for the testing devices**

	Technical data	for device type	Item no.
Voltage readback	The module allows 4-wire measurement by reading back the test voltage. Two high-voltage receptacles are also built into the back wall of the device.	G7-1A; G7-1M	G7-1A E04
Additional digital outputs	Six additional digital outputs for controlling an external switching matrix.	G7-1A; G7-1M	G7-1A E06
RS232-C	Alternative interface to Ethernet interface	G7-1A; G7-1M	G7-1A E11
USB	Alternative interface to Ethernet interface	G7-1A; G7-1M	G7-1A E12
Software package	ElutionDevice software package	G7-1A; G7-1M	N2-1A Z7B
Device driver	On request		
Calibration	Delivery with Elabo works calibration protocol	G7-1A; G7-1M	G7-1A E99-02

The description of the accessories can be found starting on page 108. Please also see our sample configurations starting on page 56. Technical specifications subject to change without notice.

Device	G7-1A	G7-1M
<b>Applications</b>		
Manual use	●	
Automated use	●	●
<b>Operation</b>		
Touch display 4.3"	●	
<b>Interface</b>		
Start button	●	
Reset button	●	●
<b>Interfaces</b>		
Ethernet	●	●
RS232-C	○	○
USB	○	○
Digital interface 1	●	●
Digital interface 2	○	○
2 Safety circuits	●	●
D/A extension module	○	○
<b>Connections</b>		
1 test probe at back	●	●
PE sensor at back	●	●
System plug at back	●	●
Voltage readback on system plug	○	○
Warning light connection at back	●	●
IEC connector at back	●	●
<b>Tests</b>		
High-voltage DC	●	●
Insulation resistance measurement	●	●
Voltage readback	○	○
<b>High-voltage testing</b>		
Test voltage	0.05 .. 6.00 kV	
Residual ripple DC	< 0.1 %	
Adjusting speed ramp	0 .. 1 kV/s	
Adjustment inaccuracy	Typ. 10V	
Voltage measurement error	0.5 % of meas. / ± 3 digit	
<b>Current measurement ranges</b>		
Measurement range 1 / resolution	500 µA / 1 µA	
Measurement range 2 / resolution	5.00 mA / 10 µA	
Current measurement error	0.5 % of meas. / ± 3 digit	
<b>Measurement of PE conductor resistance</b>		
Test voltage	12 VAC	
Test current	> 10 A (typ. 18 .. 25)	
Resistance measurement range	0 .. 500 mΩ	
Voltage drop measurement range	0 .. 5V	
Method of measurement	4-wire-measurement	
Measurement error	1.5 % of meas. / ± 3 digit	
<b>Insulation resistance measurement</b>		
Test voltage DC	0.05 .. 6.00 kV	
Measurement range 1 / resolution	0.1 .. 2.50 MΩ / 10 kΩ	
Measurement range 2 / resolution	1 .. 25.0 MΩ / 100 kΩ	
Measurement range 3 / resolution	1 .. 50 MΩ / 1 MΩ	
Accuracy of measurement	2 % of meas. / ± 5 digit	
<b>Principal technical data</b>		
Nominal capacity	30 W	
Short-circuit current	< 12 mA	
Mains connection	230V ± 10 %; 49 .. 61 Hz	
Dimensions	19" / 4 HU; depth 360 mm	
Weight	25 kg	24 kg
Allowable humidity	25 .. 75 % rel.	
Working temperature	10 .. 50 °C	
Test time	0.1 .. 999.9 s	
Memory	min. 200 data sets	



Touch Control

testsysteme.de

Flexibility is of prime importance with Elabo. That is why two versions of the devices in this line of equipment are available. Depending on the purpose, universal use or fully automated operation are possible.

● Standard    ○ Optional  
 Technical specifications subject to change without notice.



<b>Technical data</b>	<b>G7-1B / G7-1N</b>
<b>High voltage:</b>	0 .. 6.00 kVDC 0 .. 20.0 • 0 .. 200 µA • 0 .. 2.00 mA
<b>Protective earth conductor:</b>	0 .. 500 mΩ / 12 VAC / > 10 A
<b>Insulation resistance:</b>	5.00 / 50.0 / 500 MΩ • 5.00 GΩ
<b>Output:</b>	12 W
<b>Interface:</b>	Ethernet • digital interface 1
<b>Line voltage:</b>	230 V ± 10%; 49 .. 61 Hz
<b>Dimensions:</b>	19" / 4 HU; depth 360 mm
<b>Weight:</b>	25 kg • 24 kg



Front view G7-1B



Front view G7-1N

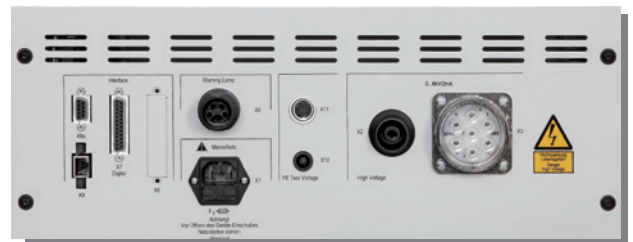

Rear view G7-1B, G7-1N

**Direct current combination testing device (HVDC)**

The testing device, which is also available as an automatic device, allows flexible possibilities for use in manual and automated systems for measurement of protective earth conductor and insulation resistance as well as for high-voltage testing in systems, assemblies and components. With its high test current resolution and wide measuring ranges for insulation resistance measurement, the unit is suitable for highly precise measurements in material investigations as well as for insulation resistance measurement in the solar industry, for instance. Accessory components configurable especially for this model round out the system. For more detailed technical data, please see the table on back.

	Description	Dimensions	Item no.
HVDC combi tester	incl. touch control unit and selector panel	19" / 4 HU	G7-1B
HVDC combi tester	for use in automated systems, incl. selector panel	19" / 4 HU	G7-1N

**Extension modules for the testing devices**

	Technical data	for device type	Item no.
Voltage readback	The module allows 4-wire measurement by reading back the test voltage. Two high-voltage receptacles are also built into the back wall of the device	G7-1B; G7-1N	G7-1B E04
Additional digital outputs	Six additional digital outputs for controlling an external switching matrix.	G7-1B; G7-1N	G7-1B E06
RS232-C	Alternative interface to Ethernet interface	G7-1B; G7-1N	G7-1B E11
USB	Alternative interface to Ethernet interface	G7-1B; G7-1N	G7-1B E12
Software package	ElutionDevice software package	G7-1B; G7-1N	N2-1A Z7B
Device driver	On request		
Calibration	Delivery with Elabo works calibration protocol	G7-1B; G7-1N	G7-1B E99-02

The description of the accessories can be found starting on page 108. Please also see our sample configurations starting on page 56. Technical specifications subject to change without notice.

## Device features G7-1B / G7-1N

**Elabo** BestPerformance

Device	G7-1B	G7-1N
Applications		
Manual use	●	
Automated use	●	●
Operation		
Touch display 4.3"	●	
Interface	●	●
Start button	●	
Reset button	●	●
Interfaces		
Ethernet	●	●
RS232-C	○	○
USB	○	○
Digital interface 1	●	●
Digital interface 2	○	○
2 Safety circuits	●	●
D/A extension module	○	○
Connections		
1 test probe at back	●	●
PE sensor at back	●	●
System plug at back	●	●
Voltage readback on system plug	○	○
Warning light connection at back	●	●
IEC connector at back	●	●
Tests		
High-voltage AC		
High-voltage DC	●	●
Insulation resistance measurement	●	●
Voltage readback	○	○
High-voltage testing		
Test voltage	0.05 .. 6.00 kV	
Residual ripple DC	< 0.01 %	
Adjusting speed ramp	0 .. 1 kV/s	
Adjustment inaccuracy	Typ. 5 V	
Voltage measurement error	0.5 % of meas. / ± 3 digit	
Current measurement ranges		
Measurement range 1 / resolution	20.0 µA / 0.1 µA	
Measurement range 2 / resolution	200 µA / 1 µA	
Measurement range 3 / resolution	2.00 mA / 10 µA	
Current measurement error	0.5 % of meas. / ± 3 digit	
Measurement of PE conductor resistance		
Test voltage	12 VAC	
Test current	> 10 A (typ. 18 .. 25)	
Resistance measurement range	0 .. 500 mΩ	
Voltage drop measurement range	0 .. 5 V	
Method of measurement	4-wire-measurement	
Measurement error	1.5 % of meas. / ± 3 digit	
Insulation resistance measurement		
Test voltage DC	0.05 .. 6.00 kV	
Measurement range 1 / resolution	0.1 .. 5.00 MΩ / 10 kΩ	
Measurement range 2 / resolution	1 .. 50.0 MΩ / 100 kΩ	
Measurement range 3 / resolution	10 .. 500 MΩ / 1 MΩ	
Measurement range 4 / resolution	0.1 .. 5.00 GΩ / 10 MΩ	
Accuracy of measurement	1 % of meas. / ± 3 digit	
Principal technical data		
Nominal capacity	12 W	
Short-circuit current	< 3 mA	
Mains connection	230 V ± 10 %; 49 .. 61 Hz	
Dimensions	19" / 4 HU; depth 360 mm	
Weight	25 kg	24 kg
Allowable humidity	25 .. 75 % rel.	
Working temperature	10 .. 50 °C	
Test time	0.1 .. 999.9 s	
Memory	min. 200 data sets	



Touch Control

testsysteme.de

Flexibility is of prime importance with Elabo. That is why two versions of the devices in this line of equipment are available. Depending on the purpose, universal use or fully automated operation are possible.

● Standard ○ Optional  
Technical specifications subject to change without notice.



<b>Technical data</b>	<b>G7-1G / G7-1T</b>
<b>High voltage:</b>	0 .. 2.50 • 5.00 kVAC 0 .. 10.00 • 100.0 mA 500 VA
<b>Protective earth conductor:</b>	0 .. 1.2 Ω; 6 oder 12 VAC; 10 .. 32 A
<b>Insulation resistance:</b>	50 .. 1.20 kVDC 10 / 100 MΩ • 1.00 GΩ
<b>Output:</b>	500 VA
<b>Interface:</b>	Ethernet • Digital interface 1
<b>Line voltage:</b>	230 V ± 10 %; 49 .. 61 Hz
<b>Dimensions:</b>	19" / 4 HU; depth 360 mm
<b>Gewicht:</b>	28 kg • 27 kg

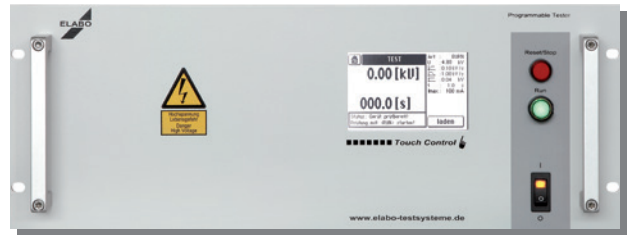

Front view G7-1G



Front view G7-1T

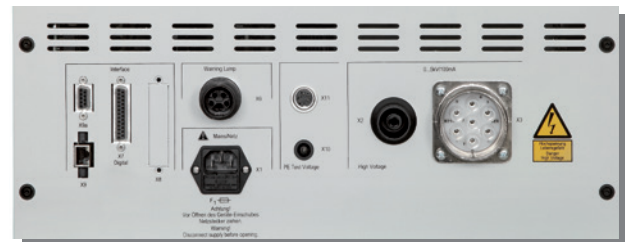

Rear view G7-1G, G7-1T

**Alternating voltage combination testing device (HVAC)**

The testing device, which is also available as an automatic device, allows flexible possibilities for use in manual and automated systems for the measurement of protective earth conductor and insulation resistance as well as for high-voltage testing in systems, assemblies and components. Accessory components configurable especially for this model round out the system. For more detailed technical data, please see the table on back.

	Description	Dimensions	Item no.
HVAC combi-tester	incl. touch control unit and selector panel	19" / 4 HU	G7-1G
HVAC combi-tester	for use in automated systems, incl. selector panel	19" / 4 HU	G7-1T

**Extension modules for the testing devices**

	Technical data	for device type	Item no.
Passive current limiting	< 3 mA bei U= 5.00 kV	G7-1G; G7-1T	G7-1G E03
Burn function	Over-current tripping can be deactivated for troubleshooting	G7-1G; G7-1T	G7-1G E05
Additional digital outputs	Six additional digital outputs for controlling an external switching matrix	G7-1G; G7-1T	G7-1G E06
RS232-C	Alternative interface to Ethernet interface	G7-1G; G7-1T	G7-1G E11
USB	Alternative interface to Ethernet interface	G7-1G; G7-1T	G7-1G E12
Software package	ElutionDevice software package	G7-1G; G7-1T	N2-1A Z7B
Device driver	On request		
Calibration	Delivery with Elabo works calibration protocol	G7-1G; G7-1T	G7-1G E99-02

The description of the accessories can be found starting on page 108. Please also see our sample configurations starting on page 56. Technical specifications subject to change without notice.

# Device features G7-1G / G7-1T

**Elabo** BestPerformance

Device	G7-1G	G7-1T
Applications		
Manual use	●	
Automated use	●	●
Operation		
Touch display 4.3"	●	
Interface	●	●
Start button	●	
Reset button	●	●
Interfaces		
Ethernet	●	●
RS232-C	○	○
USB	○	○
Digital interface 1	●	●
Digital interface 2	○	○
2 Safety circuits	●	●
D/A extension module	○	○
Connections		
1 test probe at back	●	●
PE sensor at back	●	●
System plug at back	●	●
Warning light connection at back	●	●
IEC connector at back	●	●
Tests		
High-voltage AC	●	●
Insulation resistance measurement	●	●
Passive current limiting safety feature <sup>1</sup>	○	○
Burn function <sup>1</sup>	○	○
High-voltage testing		
Test voltage 1	0.1 .. 2.50 kV	
Test voltage 2	0.2 .. 5.00 kV	
Adjusting speed ramp	0 .. 3.5 kV/s	
Adjustment inaccuracy	Typ. 10 V	
Voltage measurement error	1 % of meas. / ± 3 digit	
Current measurement ranges		
Measurement range 1 / resolution	10.00 mA / 10 µA	
Measurement range 2 / resolution	100.0 mA / 100 µA	
Current measurement error	1 % of meas. / ± 3 digit	
Active/apparent current measurement	●	
Measurement of PE conductor resistance		
Test voltage	6 / 12 VAC	
Test current	10 .. 32 A	
Resistance measurement range	0 .. 1.2 Ω <sup>2</sup>	
Voltage drop measurement range	0 .. 12 V <sup>2</sup>	
Method of measurement	4-wire-measurement	
Measurement error	1.5 % of meas. / ± 3 digit	
Insulation resistance measurement		
Test voltage DC	0.05 .. 1.20 kV	
Measurement range 1 / resolution	0.1 .. 10.0 MΩ / 100 kΩ	
Measurement range 2 / resolution	1 .. 100 MΩ / 1 MΩ	
Measurement range 3 / resolution	0.01 .. 1.00 GΩ / 10 MΩ	
Accuracy of measurement	1 % of meas. / ± 3 digit	
Principal technical data		
Nominal capacity	500 VA	
Short-circuit current	> 200 mA	
Mains connection	230 V ± 10 %; 49 .. 61 Hz	
Dimensions	19" / 4 HU; depth 360 mm	
Weight	28 kg	27 kg
Allowable humidity	25 .. 75 % rel.	
Working temperature	10 .. 50 °C	
Test time	0.1 .. 999.9 s	
Memory	min. 200 data sets	



Flexibility is of prime importance with Elabo. That is why two versions of the devices in this line of equipment are available. Depending on the purpose, universal use or fully automated operation are possible.

- Standard    ○ Optional
  - <sup>1</sup> cannot be combined
  - <sup>2</sup> depending on test current
- Technical specifications subject to change without notice.

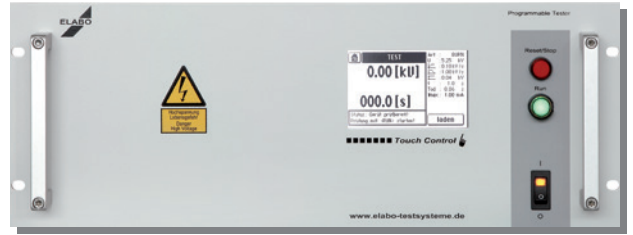
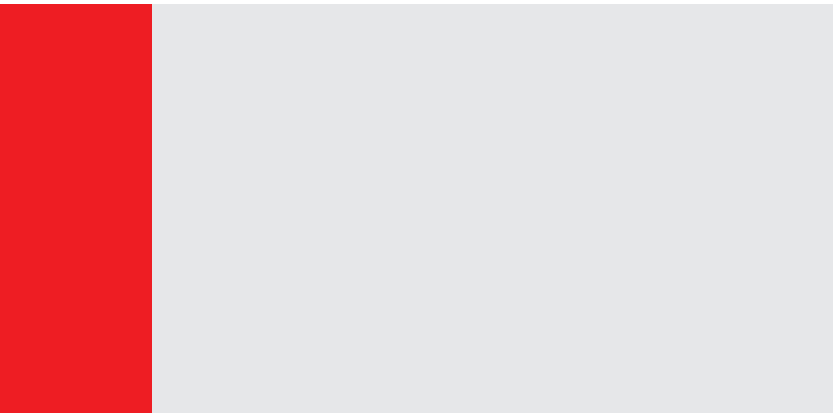







Technical data	<b>F7-1A / F7-1M</b>
High voltage:	100 .. 2.500 VAC 200 .. 5.000 VAC 200 .. 3.000 VDC (option) 300 .. 6.000 VDC (option)
Protective earth conductor:	0 .. 1.2 Ohms 6 or 12 VAC 5 .. 32 A
Interface:	RS 232-C
Mains voltage:	230 V / +/- 10 % / 49 .. 51 Hz*
Size:	19" / 6 HU
Weight:	32 kg

**Modular combination test device  
PE / IS / HV with integrated switching field**

Depending on the version and equipment status, these devices with an integrated switching field allow configuration of a compact test system for manual and automated protective earth conductor and insulation resistance measurement in addition to high-voltage testing on systems, subassemblies or components. The system is rounded off by accessories especially configurable for this version. For more detailed technical data, please see the table on back.



Front view F7-1A



Front view F7-1M

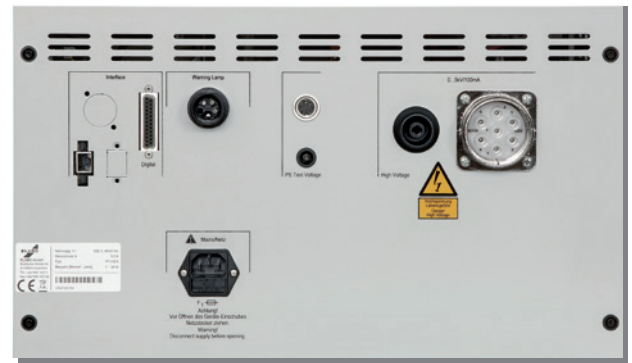

Rear view F7-1A; F7-1M

	Description	Size	Article no.
Combination tester	Incl. TouchMe control unit and integrated switching field	19"/6HU	F7-1A
Combination tester	for automatic use and integrated switching field	19"/6HU	F7-1M

**Extension modules for the test devices**

	Technical data	For device type	Article no.
DC voltage	Test voltage: 200 .. 3.000 / 6.000 VDC Tripping current: 0 .. 1 / 10 / 100 mA	F7-1A, F7-1M	F7-1A E01
Insulation resistance	0.1 .. 1 / 10 / 35 MΩ + Autorange	F7-1A, F7-1M	F7-1A E02
Safety current limitation	< 3 mA for AC; < 5 mA for DC	F7-1A, F7-1M	F7-1A E03
Voltage readback	The module allows a four-wire measurement by feedback of the test voltage. Two high-voltage sockets are additionally incorporated in the back panel of the device.	F7-1A, F7-1M	F7-1A E04
Burn-Mode	Current tripping can be deactivated for troubleshooting.	F7-1A, F7-1M	F7-1A E05
Digital additional outputs	Six additional digital outputs for activation of an external switching matrix.	F7-1A, F7-1M	F7-1A E06
Ethernet	Alternative interface to RS232-C	F7-1A, F7-1M	F7-1A E10
USB	Alternative interface to RS232-C	F7-1A, F7-1M	F7-1A E12
Software package	ElutionDevice software package	F7-1A, F7-1M	N2-1A Z7E
Device driver	On request		
Calibration	Supplied with Elabo works calibration protocol	F7-1A, F7-1M	F7-1A E99

The description of the accessories can be found starting on page 108. Please also see our sample configurations starting on page 56. \*other mains frequency on request  
Technical specifications subject to change without notice.

Device	F7-1A	F7-1M
<b>Application fields</b>		
Automatic use	●	●
Manual use	●	
<b>Operation</b>		
Touch Display 6.5"	●	
Interface	●	●
Start button	●	
Reset button	●	●
<b>Interfaces</b>		
RS 232-C	●	●
Ethernet	○	○
USB	○	○
USB accessory interface	●	
Digital interface 1	●	●
Digital interface 2	○	○
2 safety circuits	●	●
<b>Connections</b>		
1 HV test probe, rear	●	●
PE test probe, rear	●	●
System plug connector, rear	●	●
Voltage readback, rear	○	○
Warning lights	●	●
Non-heating apparatus socket	●	●
<b>Measurement types</b>		
High voltage AC	●	●
High voltage DC	○	○
PE conductor resistance measurement	●	●
Insulation resistance measurement	○	○
Current limitation (EN50191) <sup>1</sup>	○	○
Burn-Mode (deact. Tripping) <sup>1</sup>	○	○
Voltage readback	○	○
<b>High voltage</b>		
Test voltage AC1	100 .. 2.500 V	
Test voltage AC2	200 .. 5.000 V	
Test voltage DC1 <sup>2</sup>	200 .. 3.000 V	
Test voltage DC2 <sup>2</sup>	300 .. 6.000 V	
Residual ripple DC <sup>2</sup>	< 3 % bei R > 3 MΩ	
Positioning speed for ramp	10 .. 3.500 V/s	
Output frequency mains synchronous	●	
Adjustment inaccuracy	Typ. 10 V	
Accuracy, voltage	0.5% of meas. ± 2 digit	
<b>Current ranges</b>		
Measurement range 1 / resolution	0 .. 100.0 mA / 100 µA	
Measurement range 2 / resolution	0 .. 10.00 mA / 10 µA	
Measurement range 3 / resolution	0 .. 1.000 mA / 1 µA	
Current tripping	Active current – Apparent current – Crest value – Delta I	
Accuracy Apparent current	measurement range 1	0.5 % of meas. +/- 2 digit
	measurement range 2	0.5 % of meas. +/- 5 digit
	measurement range 3	0.5 % of meas. +/- 20 digit
Accuracy Peak value	measurement range 1	1.0 % of meas. +/- 5 digit
	measurement range 2	1.0 % of meas. +/- 5 digit
	measurement range 3	1.0 % of meas. +/- 20 digit
Accuracy Active current	measurement range 1	1.0 % of meas. +/- 8 digit
	measurement range 2	1.0 % of meas. +/- 8 digit
	measurement range 3	1.0 % of meas. +/- 20 digit
Accuracy DC	measurement range 1 <sup>2</sup>	0.5 % of meas. +/- 2 digit
	measurement range 2 <sup>2</sup>	0.5 % of meas. +/- 2 digit
	measurement range 3 <sup>2</sup>	0.5 % of meas. +/- 2 digit
<b>Protective earth conductor resistance measurement</b>		
Test voltage	6 / 12 VAC	
Test current	5 .. 32 A	
Measurement range resistance	0 .. 1.2 Ω <sup>3</sup>	
Measurement range Voltage drop	0 .. 12 V <sup>3</sup>	
Measurement method	4-wire-measurement	
Resolution, resistance	0.001 Ω	
Accuracy	1 % of meas. +/- 3 digit	
<b>Insulation resistance measurement<sup>2</sup></b>		
Test voltage DC 1	200 .. 3.000 V	
Test voltage DC 2	300 .. 6.000 V	
Measurement range 1 / resolution	0.1 .. 1.00 MΩ	
Measurement range 2 / resolution	1 .. 10.0 MΩ	
Measurement range 3 / resolution	10 .. 35 MΩ	
Autorange	0.1 .. 35 MΩ	
Accuracy at 500 V	3% of meas. ± 1 digit	
Accuracy at 1000 V	1% of meas. ± 1 digit	



Flexibility is of prime importance with Elabo. That is why two versions of the devices in this line of equipment are available. Depending on the purpose, universal use or fully automated operation are possible.

Principal technical data	
Nominal capacity	500 VA
Short-circuit current	>200 mA
Mains connection	230 V +/- 10%
Mains frequency	49 .. 51 Hz*
Dimensions	19" / 6 HU depth 360 mm
Weight	32 kg   31 kg
Allowable humidity	25 .. 75 % rel.
Working temperature	10 .. 50 °C
Test time	0.1 .. 999.9 sec. / constant testing
Burn-Mode current <sup>2</sup>	ca. 200 mA
<b>External extension modules</b>	
Current measurement <sup>2</sup>	On request
Voltage measurement <sup>2</sup>	On request
Power measurement <sup>2</sup>	On request

- Standard    ○ Optional
- <sup>1</sup> cannot be combined
- <sup>2</sup> Extension module required
- <sup>3</sup> depending on test current
- \*other mains frequency on request

Technical specifications subject to change without notice.



<b>Technical data</b>	<b>F7-1B / F7-1N</b>
<b>High voltage:</b>	100 .. 2.500 VAC 200 .. 5.000 VAC 200 .. 3.000 VDC (option) 300 .. 6.000 VDC (option)
<b>Protective earth conductor:</b>	0 .. 1.2 Ohms 6 or 12 VAC 5 .. 32 A
<b>Interface:</b>	RS 232-C
<b>Mains voltage:</b>	230 V / +/- 10 % / 49 .. 51 Hz*
<b>Size:</b>	19" / 6 HU
<b>Weight:</b>	30 kg

**Modular combination test device  
PE / IS / HV**

Depending on the version and equipment status, this device version allows configuration of a test system for manual and automated protective earth conductor and insulation resistance measurement in addition to high voltage testing on systems, subassemblies or components. Extension modules for switching or for integration of supplementary tests are additionally required for this version. For more detailed technical data, please see the table on back.



Front view F7-1B

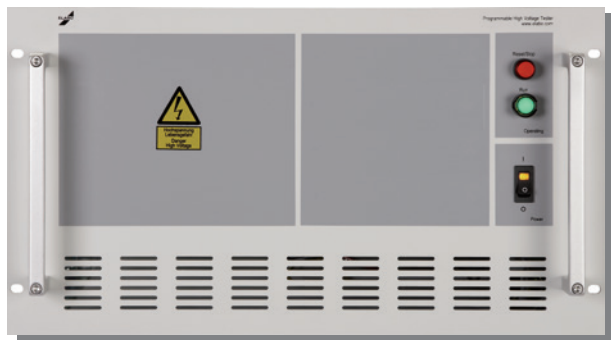

Front view F7-1N



Rear view F7-1B; F7-1N

	Description	Size	Article no.
Combination tester	Incl. TouchMe control unit	19"/6HU	F7-1B
Combination tester	for automatic use	19"/6HU	F7-1N

**Extension modules for the test devices**

	Technical data	For device type	Article no.
DC voltage	Test voltage: 200 .. 3.000 / 6.000 VDC Tripping current: 0 .. 1 / 10 / 100 mA	F7-1B, F7-1N	F7-1B E01
Insulation resistance	0.1 .. 1 / 10 / 35 MΩ + Autorange	F7-1B, F7-1N	F7-1B E02
Safety current limitation	< 3 mA for AC; < 5 mA for DC	F7-1B, F7-1N	F7-1B E03
Voltage readback	The module allows a four-wire measurement by feedback of the test voltage. Two high voltage sockets are additionally incorporated in the back panel of the device.	F7-1B, F7-1N	F7-1B E04
Burn-Mode	Current tripping can be deactivated for troubleshooting.	F7-1B, F7-1N	F7-1B E05
Digital additional outputs	Six additional digital outputs for activation of an external switching matrix.	F7-1B, F7-1N	F7-1B E06
Ethernet	Alternative interface to RS232-C	F7-1B, F7-1N	F7-1B E10
USB	Alternative interface to RS232-C	F7-1B, F7-1N	F7-1B E12
Software package	ElutionDevice software package	F7-1B, F7-1N	N2-1A Z7E
Device driver	On request		
Calibration	Supplied with Elabo works calibration protocol	F7-1B, F7-1N	F7-1B E99

The description of the accessories can be found starting on page 108.  
Please also see our sample configurations starting on page 58.  
\*other mains frequency on request  
Technical specifications subject to change without notice.

Device	F7-1B	F7-1N
<b>Application fields</b>		
Automatic use	●	●
Manual use	●	
<b>Operation</b>		
Touch Display 6.5"	●	
Interface	●	●
Start button	●	
Reset button	●	●
<b>Interfaces</b>		
RS 232-C	●	●
Ethernet	○	○
USB	○	○
USB accessory interface	●	
Digital interface 1	●	●
Digital interface 2	○	○
2 safety circuits	●	●
<b>Connections</b>		
1 HV test probe, rear	●	●
PE test probe, rear	●	●
Voltage readback, rear	○	○
Warning lights	●	●
Non-heating apparatus socket	●	●
<b>Measurement types</b>		
High voltage AC	●	●
High voltage DC	○	○
PE conductor resistance measurement	●	●
Insulation resistance measurement	○	○
Current limitation (EN50191) <sup>1</sup>	○	○
Burn-Mode (deact. Tripping) <sup>1</sup>	○	○
Voltage readback	○	○
<b>High voltage</b>		
Test voltage AC1	100 .. 2.500 V	
Test voltage AC2	200 .. 5.000 V	
Test voltage DC1 <sup>2</sup>	200 .. 3.000 V	
Test voltage DC2 <sup>2</sup>	300 .. 6.000 V	
Residual ripple DC <sup>2</sup>	< 3 % bei R > 3 MΩ	
Positioning speed for ramp	10 .. 3.500 V/s	
Output frequency mains synchronous	●	
Adjustment inaccuracy	Typ. 10 V	
Accuracy, voltage	0.5% of meas. ± 2 digit	
<b>Current ranges</b>		
Measurement range 1 / resolution	0 .. 100.0 mA / 100 µA	
Measurement range 2 / resolution	0 .. 10.00 mA / 10 µA	
Measurement range 3 / resolution	0 .. 1.000 mA / 1 µA	
Current tripping	Active current – Apparent current – Crest value – Delta I	
Accuracy Apparent current	measurement range 1	0.5 % of meas. +/- 2 digit
	measurement range 2	0.5 % of meas. +/- 5 digit
	measurement range 3	0.5 % of meas. +/- 20 digit
Accuracy Peak value	measurement range 1	1.0 % of meas. +/- 5 digit
	measurement range 2	1.0 % of meas. +/- 5 digit
	measurement range 3	1.0 % of meas. +/- 20 digit
Accuracy Active current	measurement range 1	1.0 % of meas. +/- 8 digit
	measurement range 2	1.0 % of meas. +/- 8 digit
	measurement range 3	1.0 % of meas. +/- 20 digit
Accuracy DC	measurement range 1 <sup>2</sup>	0.5 % of meas. +/- 2 digit
	measurement range 2 <sup>2</sup>	0.5 % of meas. +/- 2 digit
	measurement range 3 <sup>2</sup>	0.5 % of meas. +/- 2 digit
<b>Protective earth conductor resistance measurement</b>		
Test voltage	6 / 12 VAC	
Test current	5 .. 32 A	
Measurement range resistance	0 .. 1.2 Ω <sup>3</sup>	
Measurement range Voltage drop	0 .. 12 V <sup>3</sup>	
Measurement method	4-wire-measurement	
Resolution, resistance	0.001 Ω	
Accuracy	1 % of meas. +/- 3 digit	
<b>Insulation resistance measurement<sup>2</sup></b>		
Test voltage DC 1	200 .. 3.000 V	
Test voltage DC 2	300 .. 6.000 V	
Measurement range 1 / resolution	0.1 .. 1.00 MΩ	
Measurement range 2 / resolution	1 .. 10.0 MΩ	
Measurement range 3 / resolution	10 .. 35 MΩ	
Autorange	0.1 .. 35 MΩ	
Accuracy at 500 V	3% of meas. ± 1 digit	
Accuracy at 1000 V	1% of meas. ± 1 digit	



Flexibility is of prime importance with Elabo. That is why two versions of the devices in this line of equipment are available. Depending on the purpose, universal use or fully automated operation are possible.

**Principal technical data**

Nominal capacity	500 VA
Short-circuit current	>200 mA
Mains connection	230 V +/- 10%
Mains frequency	49 .. 51 Hz*
Dimensions	19" / 6 HU depth 360 mm
Weight	30 kg   29 kg
Allowable humidity	25 .. 75 % rel.
Working temperature	10 .. 50 °C
Test time	0.1 .. 999.9 sec. / constant testing
Burn-Mode current <sup>2</sup>	ca. 200 mA
<b>External extension modules</b>	
Current measurement <sup>2</sup>	On request
Voltage measurement <sup>2</sup>	On request
Power measurement <sup>2</sup>	On request

- Standard    ○ Optional

<sup>1</sup> cannot be combined

<sup>2</sup> Extension module required

<sup>3</sup> depending on test current

\*other mains frequency on request

Technical specifications subject to change without notice.



<b>Technical data</b>	<b>F7-1C / F7-1P</b>
<b>High voltage:</b>	100 .. 3.000 VAC 200 .. 6.000 VAC 100 .. 4.000 VDC (option) 200 .. 8.000 VDC (option)
<b>Protective earth conductor:</b>	0 .. 1.2 Ohms 6 or 12 VAC 5 .. 32 A
<b>Interface:</b>	RS 232-C
<b>Mains voltage:</b>	230 V / +/- 10 % / 49 .. 51 Hz*
<b>Size:</b>	19" / 6 HU
<b>Weight:</b>	38 kg

**Modular combination test device  
PE / IS / HV (externally synchronisable)**

Depending on the version and equipment status, this device version allows configuration of a test system for manual and automated protective earth conductor and insulation resistance measurement in addition to high voltage testing on systems, subassemblies or components. Extension modules for switching or for integration of supplementary tests are additionally required for this version. For more detailed technical data, please see the table on back.



Front view F7-1C



Front view F7-1P



Rear view F7-1C; F7-1P

	Description	Size	Article no.
Combination tester	Incl. TouchMe control unit	19"/6HU	F7-1C
Combination tester	for automatic use	19"/6HU	F7-1P

**Extension modules for the test devices**

	Technical data	For device type	Article no.
DC voltage	Test voltage: 100 .. 4.000 / 8.000 VDC Tripping current: 0 .. 1 / 10 / 100 mA	F7-1C, F7-1P	F7-1C E01
Insulation resistance	0.1 .. 1 / 10 / 35 MΩ + Autorange	F7-1C, F7-1P	F7-1C E02
Safety current limitation	< 3 mA for AC; < 5 mA for DC	F7-1C, F7-1P	F7-1C E03
Voltage readback	The module allows a four-wire measurement by feedback of the test voltage. Two high voltage sockets are additionally incorporated in the back panel of the device.	F7-1C, F7-1P	F7-1C E04
Digital additional outputs	Six additional digital outputs for activation of an external switching matrix.	F7-1C, F7-1P	F7-1C E06
Ethernet	Alternative interface to RS232-C	F7-1C, F7-1P	F7-1C E10
USB	Alternative interface to RS232-C	F7-1C, F7-1P	F7-1C E12
Software package	ElutionDevice software package	F7-1C, F7-1P	N2-1A Z7E
Device driver	On request		
Calibration	Supplied with Elabo works calibration protocol	F7-1C, F7-1P	F7-1C E99

The description of the accessories can be found starting on page 108.  
Please also see our sample configurations starting on page 58.  
\*other mains frequency on request  
Technical specifications subject to change without notice.

Device	F7-1C	F7-1P
<b>Application fields</b>		
Automatic use	●	●
Manual use	●	
<b>Operation</b>		
Touch Display 6.5"	●	
Interface	●	●
Start button	●	
Reset button	●	●
<b>Interfaces</b>		
RS 232-C	●	●
Ethernet	○	○
USB	○	○
USB accessory interface	●	
Digital interface 1	●	●
Digital interface 2	○	○
2 safety circuits	●	●
<b>Connections</b>		
2 HV test probes, rear	●	●
PE test probe, rear	●	●
Voltage readback, rear	○	○
Mains synchronisation input	●	●
Warning lights	●	●
Non-heating apparatus socket	●	●
<b>Measurement types</b>		
High voltage AC	●	●
High voltage DC	○	○
PE conductor resistance measurement	●	●
Insulation resistance measurement	○	○
Voltage readback	○	○
<b>High voltage</b>		
Test voltage AC1	100 .. 3.000 V	
Test voltage AC2	200 .. 6.000 V	
Test voltage DC1 <sup>1</sup>	100 .. 4.000 V	
Test voltage DC2 <sup>1</sup>	200 .. 8.000 V	
Residual ripple DC <sup>1</sup>	< 3 % bei R > 250 kΩ	
Positioning speed for ramp	10 .. 3.500 V/s	
Output frequency mains synchronous	●	
Output frequency synthetic	●	
Output frequency extern. synchronised	●	
Adjustment inaccuracy	Typ. 10 V	
Accuracy, voltage	0.5% of meas. ± 2 digit	
<b>Current ranges</b>		
Measurement range 1 / resolution	0 .. 100.0 mA / 100 µA	
Measurement range 2 / resolution	0 .. 10.00 mA / 10 µA	
Measurement range 3 / resolution	0 .. 1.000 mA / 1 µA	
Current tripping	Active current – Apparent current – Crest value – Delta I	
Accuracy Apparent current	measurement range 1	0.5 % of meas. +/- 2 digit
	measurement range 2	0.5 % of meas. +/- 5 digit
	measurement range 3	0.5 % of meas. +/- 20 digit
Accuracy Peak value	measurement range 1	1.0 % of meas. +/- 5 digit
	measurement range 2	1.0 % of meas. +/- 5 digit
	measurement range 3	1.0 % of meas. +/- 20 digit
Accuracy Active current	measurement range 1	1.0 % of meas. +/- 8 digit
	measurement range 2	1.0 % of meas. +/- 8 digit
	measurement range 3	1.0 % of meas. +/- 20 digit
Accuracy DC	measurement range 1 <sup>1</sup>	0.5 % of meas. +/- 2 digit
	measurement range 2 <sup>1</sup>	0.5 % of meas. +/- 2 digit
	measurement range 3 <sup>1</sup>	0.5 % of meas. +/- 2 digit
<b>Protective earth conductor resistance measurement</b>		
Test voltage	6 / 12 VAC	
Test current	5 .. 32 A	
Measurement range resistance	0 .. 1.2 Ω <sup>2</sup>	
Measurement range Voltage drop	0 .. 12 V <sup>2</sup>	
Measurement method	4-wire-measurement	
Resolution, resistance	0.001 Ω	
Accuracy	1 % of meas. +/- 3 digit	
<b>Insulation resistance measurement<sup>1</sup></b>		
Test voltage DC 1	100 .. 4.000 V	
Test voltage DC 2	200 .. 8.000 V	
Measurement range 1 / resolution	0.1 .. 1.00 MΩ	
Measurement range 2 / resolution	1 .. 10.0 MΩ	
Measurement range 3 / resolution	10 .. 35 MΩ	
Autorange	0.1 .. 35 MΩ	
Accuracy at 500 V	3% of meas. ± 1 digit	
Accuracy at 1000 V	1% of meas. ± 1 digit	



Flexibility is of prime importance with Elabo. That is why two versions of the devices in this line of equipment are available. Depending on the purpose, universal use or fully automated operation are possible.

**Principal technical data**

Nominal capacity	500 VA
Short-circuit current	>200 mA
Mains connection	230 V +/- 10%
Mains frequency	49 .. 51 Hz*
Dimensions	19" / 6 HU depth 360 mm
Weight	38 kg   37 kg
Allowable humidity	25 .. 75 % rel.
Working temperature	10 .. 50 °C
Test time	0.1 .. 999.9 s Dauerprüfung
Burn-Mode current <sup>1</sup>	ca. 200 mA
<b>External extension modules</b>	
Current measurement <sup>1</sup>	On request
Voltage measurement <sup>1</sup>	On request
Power measurement <sup>1</sup>	On request

● Standard ○ Optional

<sup>1</sup> Extension module required

<sup>2</sup> depending on test current

\*other mains frequency on request

Technical specifications subject to change without notice.

Elabo - We are  
there for you  
from the start!



# Convincing performance in practical use

**Elabo** *Best Performance*

**Requirement:**

Set up a PE/IR/HVDC test station for manual testing. The example shows a typical configuration for this application. Device components and tailor-made accessories complement each other ideally.



Description	Quantity	Item no.
HVDC combi-tester	1	G7-1A
Housing	1	93-1B
Guiding rails	1	93-1F
Test probe	1	94-2A Z06
PE test sensor	1	94-4S Z06
Connection box	1	F9-7A Z02
Hand-held start button	1	F9-1W
Calibration	1	G7-1A E99-02



**Requirement:**

Integrate a combi-tester in an automated system. For typical automated systems we offer our partners (OEM) tailor-made solutions. You can find additional useful components such as plug connectors and relays in our accessories program.

Description	Quantity	Item no.
HVAC combi-tester	1	G7-1T
Warning lights	1	F9-1A
7-pole system plug	1	94-2N Z002
Calibration	1	G7-1G E99-02



**Requirement:**

Set up a PE/IR/HVAC test station with inherent electric shock protection. Pluggable solutions can be created in combination with our test cages to maximize operator safety.

Description	Quantity	Item no.
HVAC combi-tester	1	G7-1G
Housing	1	93-1B
Guiding rails	1	93-1F
Test cage	1	94-3A ZF1
Calibration	1	G7-1G E99-02



**Requirement:**

Set up a PE/IR/HVAC test station for manual testing. The example shows a typical configuration for this application. Device components and tailor-made accessories complement each other ideally.

Description	Quantity	Item no.
HVAC combi-tester	1	G7-1G
Housing	1	93-1B
Guiding rails	1	93-1F
Test probe	1	94-2A Z06
PE test sensor	1	94-4S Z06
Connection box	1	F9-7A Z02
Hand-held start button	1	F9-1W
Calibration	1	G7-1G E99 02
Warning lights	1	F9-1A

# Convincing performance

in practical use

## Elabo High Performance

**Requirement:**

Setup of a PE / IS / HV test bench for manual testing. This example shows a typical configuration for this application. Device components and accessories tailored to needs ideally complement each other.



Description	Number	Article no.
Combination tester incl. switching field	1	F7-1A
DC extension module	1	F7-1A E01
IS extension module	1	F7-1A E02
Housing 19" / 6 HU	1	93-1C
Guide rail set	1	93-1F
High-voltage test probes, 1 x 6 m cable length	1	94-2A Z06
Protectiv earth conductor probe 6 m cable length	1	94-4S Z06
Manual start button 6 m cable length	1	F9-1W
Connection box 2.5 m cable length	1	F9-7A Z02
Warning lights, tabletop housing 1	1	94-2C

**Requirement:**

Integration of a combination tester in an automatic system. We offer our partners (OEM) tailored solutions for typical automatic use. You will find other useful components such as plug connectors and relays in our range of accessories.



Description	Number	Article no.
Combination tester incl. switching field	1	F7-1M
Warning lights, column version	1	F9-1A
System plug connector	1	94-2N Z002
Software	1	F9-9A
Calibration	1	F7-1A Z99



**Requirement:**  
Setup of a PE / HV test bench with compulsory protection against contact. In combination with our test chambers, ready-to-plug-in solutions can be produced that increase operating safety to a maximum.

Description	Number	Article no.
Combination tester incl. switching field	1	F7-1A
Housing	1	93-1C
Guide rails	1	93-1F
Test chamber with pivoting protective hood	1	94-3A ZF01

**Requirement:**  
Setup of a computer-controlled mobile test system with integrated safety and functional testing. The system deployment site is highly flexible in combination with our mobile range.

Description	Number	Article no.
Combination tester	1	F7-1N
DC extension module	1	F7-1B E01
IS extension module	1	F7-1B E02
Ethernet extension module	1	F7-1B E10
System drawer	1	F9-7M
Measurement extension module for functionality test	1	F9-7M E11
Housing	1	93-2E
Guide rail set	2	93-2F
Protective earth conductor probe	1	94-4S Z06
Two-hand operation for test mobile	1	F9-1L
Test mobile	1	T0-1T Z13
Panel PC	1	95-1C Z
Keyboard	1	95-1T
Software package	1	F9-9A
Warning lights, column version	1	F9-1B
Label printer	1	95-1X Z001



# PE conductor resistance measuring devices

Robust building blocks with a high degree of availability



## Why PE conductor resistance measurement testing?

PE conductor resistance measurement of devices in protection class 1 is one of the most important tests for household, medical and consumer devices as well as in the field of general mechanical engineering and plant engineering and construction. Verification of the efficacy of the protective earth connection between the mains connection and every exposed conductive (generally metal) housing part represents "life insurance" for users of electrical equipment. Only if this connection is 100% guaranteed for the long term can the upstream safety element safely disconnect the device from the power supply in the event of a short circuit to the housing, for instance. Inherent grounding of housing parts also prevents the creation of a dangerous voltage potential between the housing and the ground where the operator stands.

## Measurement of PE conductor resistance



The principle of measuring PE conductor resistance in products in protection class 1 is simple to understand. A current is directed from a PELV current source (usually 6 or 12 VAC no-load voltage) from the PE connection to all exposed metal parts. The resistance is determined from the voltage drop and the flowing current. Typical threshold values are between 100 and 200 mW. However, other threshold values are also used depending on the product to be tested. Because of the low test voltage, no additional safety measures are necessary in the PE test.





Whether as an individual workstation solution or as a component in a partially or fully automated testing system, in the workshop, the laboratory or in mass production – Elabo testing devices stand out because of their broad, flexible range of applications. Right from the start, the basic models of testing devices are adapted to their respective applications. Using appropriate accessories, they can also be customized at a later date to modified or expanded requirements, such as ongoing automation.

**Elabo – long-term reliable solutions in all cases.**



# Variations protective earth conductor



Device	90-2A	90-2B	90-2C	90-4F	90-4G	90-4E
Page	63	63	65	67	67	67
<b>Applications</b>						
Manual use	●	●	●	●	●	●
Automated use	●	●	●	●	●	●

<b>Operation</b>						
Digital display, 3.5 digits, selectable				● R/I	● R/I	● U/I
Analog display, selectable	● R/I	● R/I	● R/I			
Interface	●	●	●	●	●	●
Start button	●	●	●	●	●	●
Reset button	●	●	●			
Potentiometer to set test current				●		
Setting unit to set test current	●	●	●			
Potentiometer to set threshold value	●	●	●	●	●	●

<b>Interfaces</b>						
Digital interface	●	●	●	●	●	●
Analog output 0 .. 10VDC (measured value)	●	●	●	●	●	●

<b>Connections</b>						
Test sensor at front	●	●	●	●	●	●
Socket at front <sup>1</sup>	●	●	●	●	●	●
Laboratory receptacles at front	●	●	●	●	●	●
Measurement connections at back	●	●	●	●	●	●

<b>Testing parameters</b>						
Test voltage	12 VAC	12 VAC	12 VAC	10 VAC	6 VAC	6 VAC
Programmable test current				10 .. 25 A	25 A	12 A
Selectable test current	10 .. 25 A	10 .. 30 A	10 .. 50 A			
Measurement ranges	0 .. 300 mΩ	0 .. 300 mΩ	0 .. 200 mΩ	0 .. 350 mΩ	0 .. 200 mΩ	0 .. 3.5 V
Measurement error display	< 5 % of setting			1.5 % of setting / ± 2 digit		
Measurement error analog output	< 2 % of setting			1.5 % of setting / ± 2 digit		

<b>Principal technical data</b>						
Mains connection	230 V ± 10 %		230 V + 10 / - 5 %	230 V + 10 / - 5 %		
Mains frequency	49 .. 61 Hz					
Dimensions	3 HU / 36 HP	3 HU / 42 HP	19" / 4 HU	3 HU / 36 HP	3 HU / 36 HP	3 HU / 36 HP
Weight	6 kg	7 kg	30 kg	6 kg	6 kg	6 kg
Allowable humidity	25 .. 75 % rel.					
Working temperature	10 .. 50 °C					
Test time			1 s .. 99 min			

● Standard ○ Optional

<sup>1</sup> Safety socket. Other country-specific installation sockets available on request.

Technical specifications subject to change without notice.

# Testing devices and extension modules



Technical data	<b>90-2A / 90-2B</b>
Test voltage:	12 VAC
Measurement range:	0 .. 300 mΩ
Test current:	10 .. 25 A • 10 .. 30 A
Interface:	digital • Analog output
Line voltage:	230 V +/- 10%; 49 .. 61 Hz
Dimensions:	3 HU • 36 HP; 3 HU • 42 HP
Weight:	6 kg • 7 kg



Front view 90-2A



Front view 90-2B



Rear view 90-2A

## Protective earth conductor resistance measuring devices

The testing devices, which are available for various currents depending on the application, allow flexible possibilities for use in manual and automated systems for measuring PE conductor resistance in electrical equipment in protection class I. The test current can be manually preselected in these models. For more detailed technical data, please see the table on back.

## Protective earth conductor resistance measuring devices

Description	Dimensions	Item no.
10 .. 25 A; U < 12 V; 0 .. 300 mΩ	Cassette 3 HU / 36 HP	90-2A
10 .. 30 A; U < 12 V; 0 .. 300 mΩ	Cassette 3 HU / 42 HP	90-2B

## Extension modules for the testing devices

	Technical data	for device type	Item no.	
Interface	Ethernet instead of digital / analog		90-2A E10	90-2B E10
Interface	Ethernet + RS232C instead of digital / analog		90-2A E11	90-2B E11
Interface	Ethernet + USB instead of digital / analog		90-2A E12	90-2B E12
Software package	On request			
Device driver	On request			
Calibration	Delivery with Elabo works calibration protocol		90-2A E99	90-2B E99

The description of the accessories can be found starting on page 108. Please also see our sample configurations starting on page 69. Technical specifications subject to change without notice.

## Device features 90-2A / 90-2B

Device	90-2A	90-2B
Applications		
Manual use	●	●
Automated use	●	●
Operation		
Analog display, selectable	● R/I	● R/I
Interface	●	●
Start button	●	●
Reset button	●	●
Setting unit to set test current	●	●
Potentiometer to set threshold value	●	●
Interfaces		
Digital interface	●	●
Analog output 0 .. 10VDC (measured value)	●	●
Connections		
Test probe at front	●	●
Socket at front <sup>2</sup>	●	●
Laboratory receptacles at front	●	●
Measurement connections at back	●	●
Testing parameters		
Test voltage	12 VAC	12 VAC
Selectable test current	10 .. 25 A	10 .. 30 A
Measurement ranges	0 .. 300 mΩ	0 .. 300 mΩ
Measurement error display	< 5 % of setting	
Measurement error analog output	< 2 % of setting	
Principal technical data		
Mains connection	230 V ± 10 %	
Mains frequency	49 .. 61 Hz	
Dimensions	3 HU / 36 HP	3 HU / 42 HP
Weight	6 kg	7 kg
Allowable humidity	25 .. 75 % rel.	
Working temperature	10 .. 50 °C	

● Standard ○ Optional

<sup>1</sup>Safety socket.

Other country-specific installation sockets available on request.  
 Technical specifications subject to change without notice.

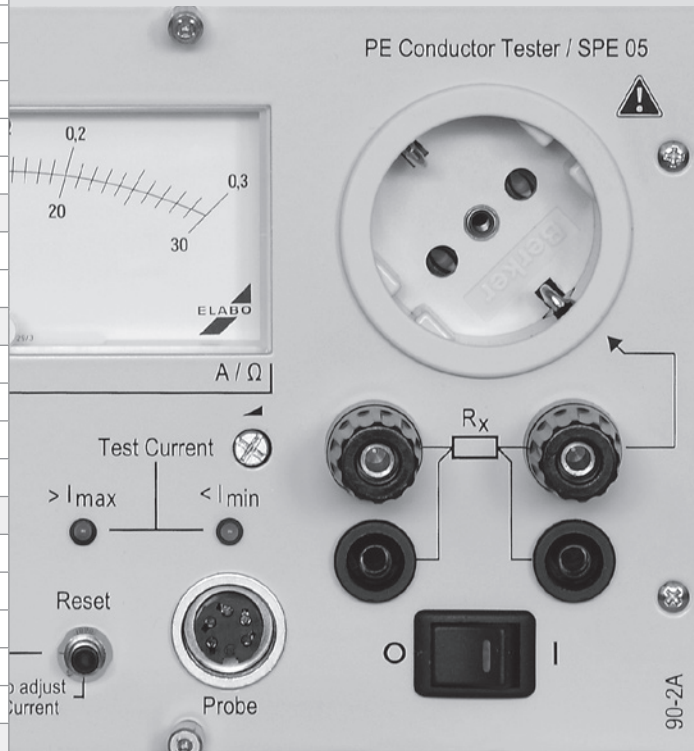



# Testing devices and extension modules



Technical data	<b>90-2C</b>
Test voltage:	12 VAC
Measurement range:	0 .. 200 mΩ
Test current:	10 .. 50 A
Timer:	1 s .. 99 min
Interface:	digital • Analog output
Line voltage:	230 V + 10 /- 5 %; 49 .. 61 Hz
Dimensions:	19" / 4 HU
Weight:	30 kg



Front view 90-2C



Rear view 90-2C

## Protective earth conductor resistance measuring device

The testing device allows flexible possibilities for use in manual and automated systems for measuring PE conductor resistance with increased test current in electrical equipment in protection class I. The test current can be manually pre-selected in this model. For more detailed technical data, please see the table on back.

## Protective earth conductor resistance measuring device

Description	Dimensions	Item no.
10 .. 50 A; U < 12 V; 0 .. 200 mΩ	19" / 4 HU	90-2C

## Extension modules for the testing devices

	Technical data	for device type	Item no.
Interface	On request		
Software package	On request		
Device driver	On request		
Calibration	Delivery with Elabo works calibration protocol	90-2C	90-2C E99

The description of the accessories can be found starting on page 108. Please also see our sample configurations starting on page 69. Technical specifications subject to change without notice.

Additional PE resistance measurement devices are available on request, according to specification.

Examples:

- special models for testing EHB systems in the automotive industry
- switching cabinet installation modules
- special OEM models



## Device features 90-2C

Device	90-2C
Applications	
Manual use	●
Automated use	●
Operation	
Analog display, selectable	● R/I
Interface	
Start button	●
Reset button	●
Setting unit to set test current	●
Potentiometer to set threshold value	●
Interfaces	
Digital interface	●
Analog output 0 .. 10VDC (measured value)	●
Connections	
Test probe at front	●
Socket at front <sup>1</sup>	●
Laboratory receptacles at front	●
Measurement connections at back	●
Testing parameters	
Test voltage	12 VAC
Programmable test current	10 .. 50 A
Measurement ranges	0 .. 200 mΩ
Measurement error display	< 5 % of setting
Measurement error analog output	< 2 % of setting
Principal technical data	
Mains connection	230V + 10 / - 5 %
Mains frequency	49 .. 61 Hz
Dimensions	19" / 4 HU
Weight	30 kg
Allowable humidity	25 .. 75 % rel.
Working temperature	10 .. 50 °C
Test time	1 s .. 99 min

● Standard ○ Optional

<sup>1</sup>Safety socket.

Other country-specific installation sockets available on request.  
Technical specifications subject to change without notice.



# Testing devices and extension modules



Technical data	90-4F	90-4G	90-4E
Test voltage:	10 VAC	6 VAC	6 VAC
Measurement range:	350 mΩ	200 mΩ	3.5V
Test current:	25 A	25 A	12 A
Interface:	digital • Analog output		
Line voltage:	230 V +10 /- 5 %; 49 .. 61 Hz		
Dimensions:	3 HU • 36 HP		
Weight:	6 kg		



Front view 90-4F



Front view 90-4G



Rear view 90-4E, 90-4F, 90-4G

## Protective earth conductor resistance measuring devices

The testing devices, which are also available in various models depending on the application, allow flexible possibilities for use in manual and automated systems for measuring PE conductor resistance in electrical equipment in protection class I. The electronically regulated test current allows testing with a constant current. For more detailed technical data, please see the table on back.

## Protective earth conductor resistance measuring devices

	Description	Dimensions	Item no.
Universal	25 A; U < 10 V; 0 .. 350 mΩ	Cassette 3 HU / 36 HP	90-4F
Medical equipment	25 A; U < 6 V; 0 .. 200 mΩ	Cassette 3 HU / 36 HP	90-4G
Voltage drop measurement	12 A; U < 6 V; 0 .. 3.5 V	Cassette 3 HU / 36 HP	90-4E

## Extension modules for the testing devices

	Technical data	for device type	Item no.
Interface	Ethernet instead of digital / analog		90-4F E10    90-4G E10    90-4E E10
Interface	Ethernet + RS232C instead of digital / analog		90-4F E11    90-4G E11    90-4E E11
Interface	Ethernet + USB instead of digital / analog		90-4F E12    90-4G E12    90-4E E12
Software package	On request		
Device driver	On request		
Calibration	Delivery with Elabo works calibration protocol		90-4F E99    90-4G E99    90-4E E99

The description of the accessories can be found starting on page 108. Please also see our sample configurations starting on page 69. Technical specifications subject to change without notice.

## Device features 90-4F / 90-4G / 90-4E

Device	90-4F	90-4G	90-4E
<b>Applications</b>			
Manual use	●	●	●
Automated use	●	●	●
<b>Operation</b>			
Digital display, 3.5 digits, selectable	● R/I	● R/I	● U/I
Interface	●	●	●
Start button	●	●	●
Potentiometer to set test current	●		
Potentiometer to set threshold value	●	●	●
<b>Interfaces</b>			
Digital interface	●	●	●
Analog output 0 .. 10VDC (measured value)	●	●	●
<b>Connections</b>			
Test probe at front	●	●	●
Socket at front <sup>1</sup>	●	●	●
Laboratory receptacles at front	●	●	●
Measurement connections at back	●	●	●
<b>Testing parameters</b>			
Test voltage	10 VAC	6 VAC	6 VAC
Programmable test current	10 .. 25 A	25 A	12 A
Measurement ranges	0 .. 350 mΩ	0 .. 200 mΩ	0 .. 3.5 V
Measurement error display	1.5 % of setting / ± 2 digit		
Measurement error analog output	1.5 % of setting / ± 2 digit		
<b>Principal technical data</b>			
Mains connection	230 V + 10 / - 5 %		
Mains frequency	49 .. 61 Hz		
Dimensions	3 HU / 36 HP	3 HU / 36 HP	3 HU / 36 HP
Weight	6 kg	6 kg	6 kg
Allowable humidity	25 .. 75 % rel.		
Working temperature	10 .. 50 °C		

● Standard ○ Optional

<sup>1</sup>Safety socket.

Other country-specific installation sockets available on request.  
 Technical specifications subject to change without notice.



# Superior performance in practical applications

**Requirement:**  
Portable PE conductor testing device for use at a test station or as a mobile unit. This example shows a typical configuration for this application.



Description	Quantity	Item no.
PE conductor testing device 12 VAC 10 .. 25 A	1	90-4F
Housing	1	30-6M
Test sensor	1	94-4S
Calibration	1	90-4F E99

**Requirement:**  
PE conductor testing device for use in automated systems. A 19"-module rack allows the installation of a switching cabinet. You can find additional useful components such as test sensors and extra blank panels in our accessories program.



Description	Quantity	Item no.
PE conductor testing device 25 A	1	90-4G
Module rack with 24-pole system plug	1	94-1R
Blank panel	1	40-1A
Blank panel	1	40-1D
Calibration	1	90-4G E99

**Requirement:**  
Test system for combined PE conductor and insulation resistance measurement in a practical portable housing. This unit is also available in a model with separate measurement functions. You can find additional useful components such as test sensors and extra blank panels in our accessories program.



Description	Quantity	Item no.
PE conductor testing device 12 VAC 10 .. 25 A	1	90-2A
Insulation resistance measuring device 500 VDC; 10/100MΩ	1	90-2E
Housing (combined measurement)	1	30-6R
Test sensor	1	94-4S
Calibration	1	90-2A E99
Calibration	1	90-2E E99

Please also see our combi-testers beginning on page 38. Combi-testers combine PE conductor measurement with high-voltage and insulation resistance measurements in one device.

# Insulation resistance measuring devices

High-ohm measuring technology



## Why insulation resistance measurement?

Insulation resistance measurement of insulation materials and of electric devices and equipment. Insulation faults can result in leakage current, which can endanger the operator. In particular with devices in protection class II, but also with other protection classes, the test is used to ensure that the measurement results are within the acceptable range. Measurements also play an important role in the performance of repeat tests. The test can also be an important indicator of the quality of the manufacturing process when testing insulation materials (e.g. in the solar industry).

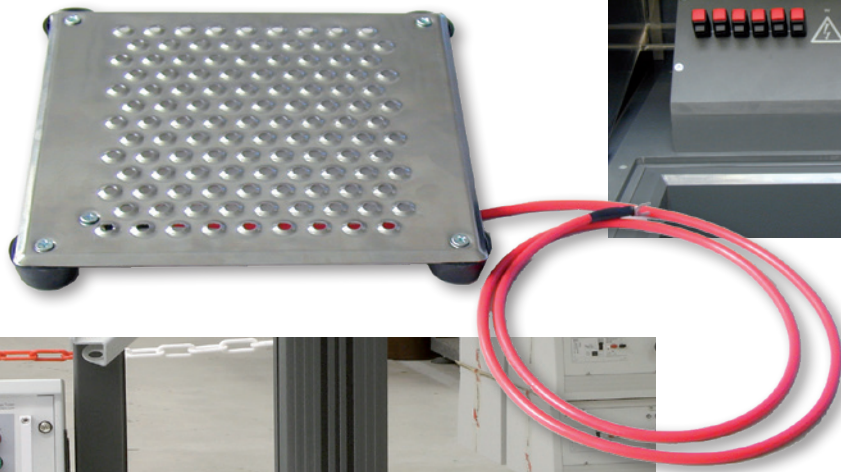

### Insulation resistance measurement

Measurement of the insulation resistance assesses the actual effective resistance component of the insulation material. The test current used is generally 500 V DC, and it is applied between active and inactive parts of the test object.

Applicable threshold values are usually in the 1 .. 100 M $\Omega$  range.

Whether as an individual workstation solution or as a component in a partially or fully automated testing system, in the workshop, the laboratory or in mass production – Elabo testing devices stand out because of their broad, flexible range of applications. Right from the start, the basic models of testing devices are adapted to their respective applications. Using appropriate accessories, they can also be customized at a later date to modified or expanded requirements, such as ongoing automation.

**Elabo – long-term reliable solutions in all cases.**



# Variations insulation resistance



Device	90-4K	90-2E
Page	73	75

Applications		
Manual use	●	●
Automated use	●	●

Operation		
Digital display, 3.5 digits	●	
Analog display		●
Interface digital	●	●
Start button	●	●
Potentiometer to set threshold value	●	●
Configurable test voltage (internal)	●	
Configurable measurement range (internal)	●	
Potentiometer to set voltage	●	
Selector for fixed/variable voltage	●	

Interfaces		
Digital interface	●	●
Analog output 0 .. 10VDC (measured value)	●	●

Connections		
Socket at front <sup>1</sup>	●	●
Laboratory receptacles at front	●	●
Shielding connection at front	●	
Measurement connections at back	●	●

Testing parameters		
Test voltage 1	50 .. 550 VDC	500 VDC
Test voltage 2	500 .. 1000 VDC	
Test current	< 12 mA	< 3 mA
Measurement range 1	0 .. 10.00 MΩ	0 .. 10 MΩ
Measurement range 2	0 .. 100.0 MΩ	0 .. 100 MΩ
Measurement range 3	0 .. 1000 MΩ	
Measurement error display	< 3 % of Setting	< 5 % of Setting
Measurement error analog output	< 2 % of Setting	< 2 % of Setting

Principal technical data		
Mains connection		230 V ± 10 %
Mains frequency		49 .. 61 Hz
Dimensions		3 HU / 36 HP
Weight	2.8 kg	1.3 kg
Allowable humidity		25 .. 75 % rel.
Working temperature		10 .. 50 °C

● Standard ○ Optional

<sup>1</sup> Safety socket.

Other country-specific installation sockets available on request.

Technical specifications subject to change without notice.



# Testing devices and extension modules



<b>Technical data</b>	<b>90-4K</b>
<b>Test voltage:</b>	50 .. 550 VDC 500 .. 1000 VDC
<b>Measurement ranges:</b>	0 .. 10 • 100 • 1000 MΩ
<b>Test current:</b>	< 12 mA
<b>Interface:</b>	digital • Analog output
<b>Line voltage:</b>	230 V +/- 10%; 49 .. 61 Hz
<b>Dimensions:</b>	3 HU / 36 HP
<b>Weight:</b>	2.8 kg



Front view 90-4K

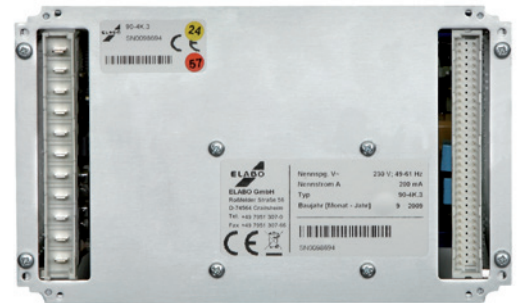

Rear view 90-4K

## Insulation resistance measuring device

The testing devices allow flexible possibilities for use in manual and automated systems for insulation resistance measurement in electrical devices and insulation materials. The configurable voltage and measurement ranges permit flexible adjustment to a wide range of test specifications. For more detailed technical data, please see the table on back.

	Description	Dimensions	Item no.
Insulation resistance measuring device	50 .. 550 / 500 .. 1000 VDC; 10/100/1000 MΩ	Cassette 3 HU / 36 HP	90-4K

## Extension modules for the testing devices

	Technical data	for device type	Item no.
Interface	Ethernet instead of digital / analog	90-4K	90-4K E10
Interface	Ethernet + RS232C instead of digital / analog	90-4K	90-4K E11
Interface	Ethernet + USB instead of digital / analog	90-4K	90-4K E12
Software package	On request		
Device driver	On request		
Other measurement ranges	On request		
Calibration	Delivery with Elabo works calibration protocol	90-4K	90-4K E99

The description of the accessories can be found starting on page 108.  
Please also see our sample configurations starting on page 77.  
Technical specifications subject to change without notice.

## Device features 90-4K

Device	90-4K
Applications	
Manual use	●
Automated use	●
Operation	
Digital display, 3.5 digits	●
Interface digital	●
Start button	●
Potentiometer to set threshold value	●
Configurable test voltage (internal)	●
Configurable measurement range (internal)	●
Potentiometer to set voltage	●
Selector for fixed/variable voltage	●
Interfaces	
Digital interface	●
Analog output 0 .. 10VDC (measured value)	●
Connections	
Socket at front <sup>1</sup>	●
Laboratory receptacles at front	●
Shielding connection at front	●
Measurement connections at back	●
Testing parameters	
Test voltage 1	50 .. 550 VDC
Test voltage 2	500 .. 1000 VDC
Test current	< 12 mA
Measurement range 1 <sup>2</sup>	0 .. 10.00 MΩ
Measurement range 2 <sup>2</sup>	0 .. 100.0 MΩ
Measurement range 3 <sup>2</sup>	0 .. 1000 MΩ
Measurement error display	< 3 % of setting
Measurement error analog output	< 2 % of setting
Principal technical data	
Mains connection	230 V ± 10 %
Mains frequency	49 .. 61 Hz
Dimensions	3 HU / 36 HP
Weight	2.8 kg
Allowable humidity	25 .. 75 % rel.
Working temperature	10 .. 50 °C

● Standard ○ Optional

<sup>1</sup>Safety socket.

<sup>2</sup>Internal configuration measurement range 1+2 or 2+3

Other country-specific installation sockets available on request.

Technical specifications subject to change without notice.

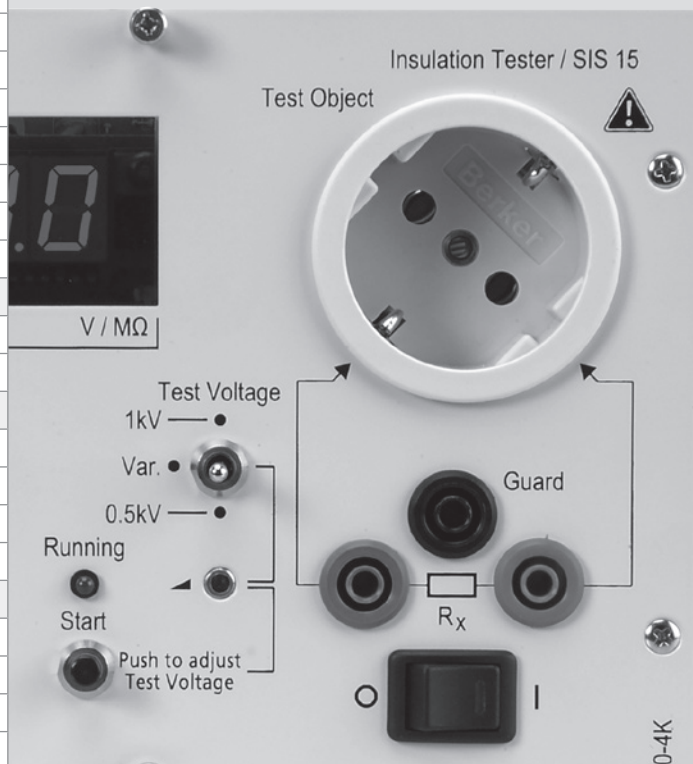

# Testing devices and extension modules



<b>Technical data</b>	<b>90-2E</b>
Test voltage:	500 VDC
Measurement ranges:	0 .. 10 • 100 MΩ
Test current:	< 3 mA
Interface:	digital • Analog output
Line voltage:	230 V +/- 10%; 49 .. 61 Hz
Dimensions:	3 HU / 36 HP
Weight:	1.3 kg



Front view 90-2E



Rear view 90-2E

## Insulation resistance measuring device

The testing devices allow flexible possibilities for use in manual and automated systems for insulation resistance measurement in electrical devices and insulation materials. The selectable measurement range permits flexible adjustment to a wide range of test specifications. For more detailed technical data, please see the table on back.

	Description	Dimensions	Item no.
Insulation resistance measuring device	550 VDC; 10/100 MΩ	Cassette 3 HU / 36 HP	90-2E

## Extension modules for the testing devices

	Technical data	for device type	Item no.
Interface	Ethernet instead of digital / analog	90-2E	90-2E E10
Interface	Ethernet + RS232C instead of digital / analog	90-2E	90-2E E11
Interface	Ethernet + USB instead of digital / analog	90-2E	90-2E E12
Software package	On request		
Device driver	On request		
Other test voltages	On request		
Other measurement ranges	On request		
Calibration	Delivery with Elabo works calibration protocol	90-2E	90-2E E99

The description of the accessories can be found in the description starting on page 108. Please also see our configuration examples on page 77. Technical specifications subject to change without notice.

## Device features 90-2E

Device	90-2E
Applications	
Manual use	●
Automated use	●
Operation	
Analog display	●
Interface digital	●
Start button	●
Potentiometer to set threshold value	●
Interfaces	
Digital interface	●
Analog output 0 .. 10VDC (measured value)	●
Connections	
Socket at front <sup>1</sup>	●
Laboratory receptacles at front	●
Measurement connections at back	●
Testing parameters	
Test voltage	500 VDC
Test current	< 3 mA
Measurement range 1	0 .. 10 MΩ
Measurement range 2	0 .. 100 MΩ
Measurement error display	< 5 % of setting
Measurement error analog output	< 2 % of setting
Principal technical data	
Mains connection	230 V ± 10 %
Mains frequency	49 .. 61 Hz
Dimensions	3 HU / 36 HP
Weight	1.3 kg
Allowable humidity	25 .. 75 % rel.
Working temperature	10 .. 50 °C

● Standard ○ Optional

<sup>1</sup>Safety socket.

Other country-specific installation sockets available on request.  
Technical specifications subject to change without notice.

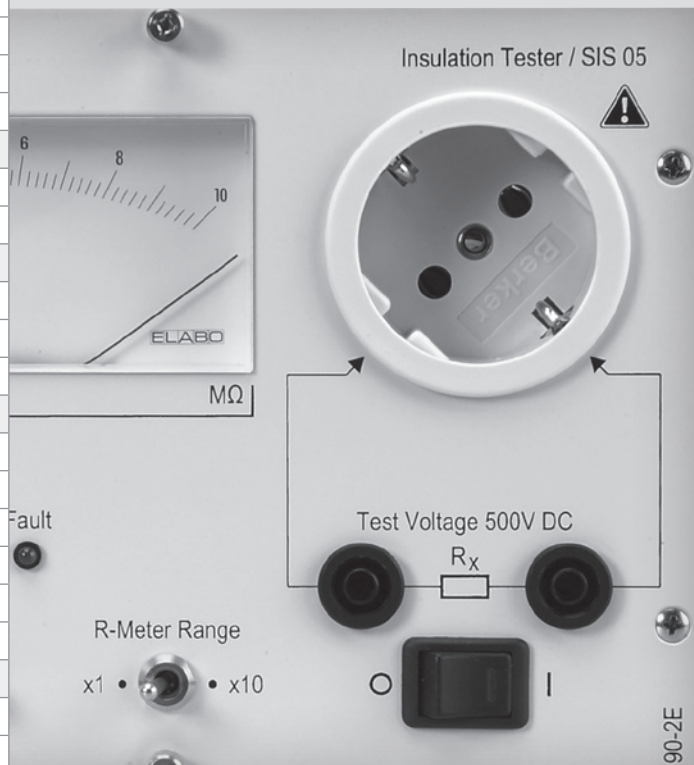

# Sample configurations

**Requirement:**

Portable insulation resistance testing device for use at a test station or as a mobile unit. This example shows a typical configuration for this application.



Description	Quantity	Item no.
Insulation resistance measuring device 50 .. 1000 VDC	1	90-4K
Housing	1	30-6M
Calibration	1	90-4K E99

**Requirement:**

Test system for PE conductor and insulation resistance measurement in a practical portable housing. This unit is also available in a model with combined measurement function. You can find additional useful components such as test sensors and extra blank panels in our accessories program.



Description	Quantity	Item no.
Insulation resistance measuring device	1	90-4K
Blank panel	1	40-1A
PE conductor testing device 12 VAC 10 .. 25 A	1	90-4F
Housing	1	30-6N
Calibration	1	90-4K E99
Calibration	1	90-4F E99

**Requirement:**

PE conductor testing device for use in automated systems. A 19" module rack allows the installation of a switching cabinet. You can find additional useful components such as test sensors and extra blank panels in our accessories program.

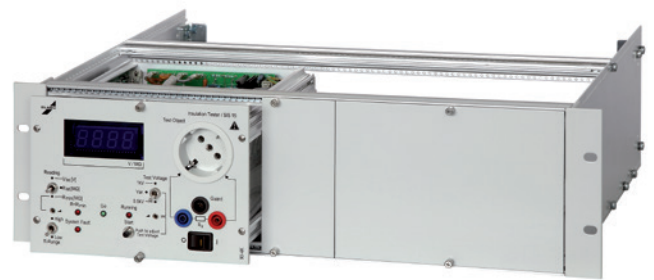

Description	Quantity	Item no.
Insulation resistance measuring device 50 .. 1000 VDC	1	90-4K
Module rack with 24-pole system plug	1	94-1R
Blank panel 12 HP	1	40-1A
Blank panel 36 HP	1	40-1D
Calibration	1	90-4K E99

Please also see our DC high-voltage testing devices beginning on page 14 and the combi-testers beginning on page 38. These devices combine insulation resistance measurement with high-voltage and (in combi-testers) PE conductor measurement in one device.



# Leakage current measuring devices

On the trail of the  $\mu\text{A}$



## Why leakage current measurement?

Measurement of leakage current is required in some bodies of standards – especially for type testing – to complete the measurements of electric devices and equipment in various protection classes. Insulation faults can result in leakage current, which can endanger the operator. The test ensures that these currents – both in normal operation and in the event of a fault – are within the acceptable range. This measurement is particularly important in the case of medical equipment used in operating rooms. The measurement also plays an important role in the performance of repeat tests.





### Leakage current measurement

A leakage current test determines the current that would flow through a person in the event of a fault (interruption of the protective earth conductor circuit in devices in protection class I or an insulation fault in devices in protection class II). During the test the device being tested is operated normally with an elevated voltage (factor of 1.06- 1.1). The transposition of the live and neutral connections (test types A1, A2) – or the breakdown of phases in three-phase devices – is also simulated during the test. The requirements placed on the testing devices are regulated by various standards, and these standards attach importance to different effects of the electric current. It is therefore necessary that the testing devices be able to determine the effective value, the average value, the peak value or the alternating component of the leakage current. The required measured bandwidth is 1 MHz. In order to prevent incorrect measurements when measuring leakage current, it is imperative that an ungrounded supply voltage be used or that the device being tested be insulated. During the test, depending on the type of connection, voltage may pass through the exposed metal parts of the device being tested. Appropriate safety precautions must therefore be taken during testing. The standards generally require measurement of leakage current for type testing and only occasionally for routine testing.

Whether as an individual workstation solution or as a component in a partially or fully automated testing system, in the workshop, the laboratory or in mass production – Elabo testing devices stand out because of their broad, flexible range of applications. Right from the start, the basic models of testing devices are adapted to their respective applications. Using appropriate accessories, they can also be customized at a later date to modified or expanded requirements, such as ongoing automation.

**Elabo – long-term reliable solutions in all cases.**



# Variations leakage current

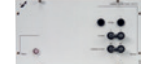

Device	92-4A	92-4D	92-4G	90-2M
Page	81	83	85	87
<b>Applications</b>				
Manual use	●	●	●	
Automated use	●	●	●	●
<b>Operation</b>				
LCD display	●			
Interface	●	●	●	●
Start button	●	●	●	
<b>Interfaces</b>				
RS232-C	●	●	●	○
Digital interface				●
Analog output 0 .. 10VDC (measured value)				●
<b>Connections</b>				
1~ socket at front	●	●	●	
3~ socket at front			●	
Laboratory receptacles at front	●	●	●	
Calibration receptacles at front				●
Measurement connections at back	●	●	●	●
<b>Testing parameters</b>				
Test voltage internal	Mains .. 280 V	50 .. 280 V		
Test voltage programmable	○	○		
Test voltage internal potential-free		●		
Test current internal	0 .. 15 A	0 .. 4 A		
Test voltage external	50 .. 280 V	50 .. 280 V	50 .. 280 V / 50 .. 480 V	50 .. 280 V
Test current external	0 .. 15 A	0 .. 15 A	0 .. 32 A	0 .. 15 A
Frequency external	50 .. 400 Hz			
Measurement range / resolution	0 .. 100 µA	0 .. 100 µA	0 .. 100 µA	0 .. 100 µA
Measurement error, measurement range 1 <sup>2</sup> TRMS; MAD; alternating component	1 % of meas. + 10 digit	1 % of meas. + 10 digit	1 % of meas. + 10 digit	1 % of meas. + 3 µA
Measurement error, measurement range 1 <sup>2</sup> Direct component; peak value	2 % of meas. + 30 digit µA	2 % of meas. + 30 digit µA	2 % of meas. + 30 digit µA	
Measurement error, measurement range 2 / resolution	0 .. 1 mA	0 .. 1 mA	0 .. 1 mA	0 .. 1 mA
Measurement error, measurement range 2 <sup>2</sup> TRMS; MAD; alternating component	1 % of meas. + 10 digit µA	1 % of meas. + 10 digit µA	1 % of meas. + 10 digit µA	1 % of meas. + 5 µA
Measurement error, measurement range 1 <sup>2</sup> Direct component; peak value	2 % of meas. + 30 digit	2 % of meas. + 30 digit	2 % of meas. + 30 digit	
Measurement error, measurement range 3 / resolution	0 .. 10 mA	0 .. 10 mA	0 .. 10 mA	0 .. 10 mA
Measurement error, measurement range 3 <sup>2</sup> TRMS; MAD; alternating component	1 % of meas. + 10 digit	1 % of meas. + 10 digit	1 % of meas. + 10 digit	1 % of meas. + 50 µA
Measurement error, measurement range 1 <sup>2</sup> Direct component; peak value	2 % of meas. + 30 digit	2 % of meas. + 30 digit	2 % of meas. + 30 digit	
Measured bandwidth of measurement amplifier	DC; 50 Hz .. 1 MHz			
Effective value measurement	● <sup>1</sup>	● <sup>1</sup>	● <sup>1</sup>	●
Average value measurement	● <sup>1</sup>	● <sup>1</sup>	● <sup>1</sup>	
Peak value measurement	● <sup>1</sup>	● <sup>1</sup>	● <sup>1</sup>	
AC component	● <sup>1</sup>	● <sup>1</sup>	● <sup>1</sup>	
DC component	● <sup>1</sup>	● <sup>1</sup>	● <sup>1</sup>	
<b>Principal technical data</b>				
Memory	200 data sets			
Mains connection	230 V ± 10 %; 49 .. 61 Hz			
Dimensions	19" / 4 HU			3HU / 48 HP
Weight	31 kg	28 kg	20 kg	4 kg
Allowable humidity	25 .. 75 % rel.			
Working temperature	10 .. 50 °C			
Test timer	1 s .. 24 h			

● Standard ○ Optional

<sup>1</sup> Dependent on the testing standard applied. Please also request the respective standards when ordering.

<sup>2</sup> Evaluated at DC / 50 .. 60 Hz

Technical specifications subject to change without notice



# Testing devices and extension modules



grounded

<b>Technical data</b>	<b>92-4A</b>
<b>Test voltage:</b>	Mains .. 280 VAC internal 50 .. 280 VAC external
<b>Test current:</b>	0 .. 15 A
<b>Measurement ranges:</b>	0 .. 100 µA • 0 .. 1.00 mA • 0 .. 10.0 mA
<b>Test methodology:</b>	varies accord. to standard
<b>Interface:</b>	RS232-C
<b>Line voltage:</b>	230 V ± 10%; 49 .. 61 Hz
<b>Dimensions:</b>	19" / 4 HU
<b>Weight:</b>	31 kg



Front view 92-4A



Rear view 92-4A

## Leakage current measuring device

The testing device for performing grounded leakage current measurement in single-phase units undergoing test allows the measurement of leakage current in electrical devices in accordance with standards. Individual measuring devices can be configured in combination with up to three associated measuring circuits and the corresponding extension modules. For more detailed technical data, please see the table on back.

	Description	Dimensions	Item no.
Leakage current measuring device	Mains .. 280 VAC, grounded	19" / 4HU	92-4A
Leakage current measuring device	same with automatic current setting	19" / 4HU	92-4A Z01

## Extension options

	Technical data	for device type	Item no.
Measuring circuit	VDE 0711 / EN 60598-1	92-4A; 92-4A Z01	92-4R Z02
Measuring circuit	VDE 0750 / EN 60601	92-4A; 92-4A Z01	92-4R Z03
Measuring circuit	VDE 0805 / EN 60950	92-4A; 92-4A Z01	92-4R Z04
Measuring circuit	VDE 0860 / EN 60065	92-4A; 92-4A Z01	92-4R Z05
Measuring circuit	VDE 0411 / EN 61010	92-4A; 92-4A Z01	92-4R Z06
Measuring circuit	VDE 0700 / EN 60335-1	92-4A; 92-4A Z01	92-4R Z07
Measuring circuit	Others on request	92-4A; 92-4A Z01	
Extension module	Medical equipment	92-4A; 92-4A Z01	92-4R Z11
Software	On request		
Device driver	On request		
Calibration	Delivery with Elabo works calibration protocol	92-4A; 92-4A Z01	92-4A Exx*

The description of the accessories can be found in the description starting on page 108.

Please also see our configuration examples on page 89.

\* Depending on configuration

Technical specifications subject to change without notice.

## Device features 92-4A

Device	92-4A
<b>Applications</b>	
Manual use	●
Automated use	●
<b>Operation</b>	
LCD display	●
Interface	●
Start button	●
<b>Interfaces</b>	
RS232-C	●
<b>Connections</b>	
1~ socket at front	●
Laboratory receptacles at front	●
Measurement connections at back	●
<b>Testing parameters</b>	
Test voltage internal	Mains .. 280 V
Test voltage programmable	○
Test current internal	0 .. 15 A
Test voltage external	50 .. 280 V
Test current external	0 .. 15 A
Frequency external	50 .. 400 Hz
Measurement range / resolution	0 .. 100 µA
Measurement error, measurement range 1 <sup>2</sup> TRMS; MAD; alternating component	1 % of meas. + 10 digit
Measurement error, measurement range 1 <sup>2</sup> Direct component; peak value	2 % of meas. + 30 digit µA
Measurement error, measurement range 2 / resolution	0 .. 1 mA
Measurement error, measurement range 2 <sup>2</sup> TRMS; MAD; alternating component	1 % of meas. + 10 digit µA
Measurement error, measurement range 1 <sup>2</sup> Direct component; peak value	2 % of meas. + 30 digit
Measurement error, measurement range 3 / resolution	0 .. 10 mA
Measurement error, measurement range 3 <sup>2</sup> TRMS; MAD; alternating component	1 % of meas. + 10 digit
Measurement error, measurement range 1 <sup>2</sup> Direct component; peak value	2 % of meas. + 30 digit
Measured bandwidth of measurement amplifier	DC; 50 Hz .. 1 MHz
Effective value measurement	● <sup>1</sup>
Average value measurement	● <sup>1</sup>
Peak value measurement	● <sup>1</sup>
AC component	● <sup>1</sup>
DC component	● <sup>1</sup>
<b>Principal technical data</b>	
Memory	200 data sets
Mains connection	230 V ± 10 %; 49 .. 61 Hz
Dimensions	19" / 4 HU
Weight	31 kg
Allowable humidity	25 .. 75 % rel.
Working temperature	10 .. 50 °C
Test timer	1 s .. 24 h

● Standard ○ Optional

<sup>1</sup> Dependent on the testing standard applied.

Please also request the respective standards when ordering.

<sup>2</sup> Evaluated at DC / 50 .. 60 Hz

Technical specifications subject to change without notice

# grounded



# Testing devices and extension modules



potential-free

Technical data	<b>92-4D</b>
Test voltage:	50 .. 280 VAC internal 50 .. 280 VAC external
Test current:	0 .. 4 A intern 0 .. 15 A extern
Measurement ranges:	0 .. 100 $\mu$ A • 0 .. 1.00 mA • 0 .. 10.0 mA
Test methodology:	varies according to standard
Interface:	RS232-C
Line voltage:	230 V $\pm$ 10 %; 49 .. 61 Hz
Dimensions:	19" / 4 HU
Weight:	28 kg



Front view 92-4D



Rear view 92-4D

## Leakage current measuring device

The testing device used for potential-free measurement of leakage current in single-phase units undergoing test allows the measurement of leakage current in electrical devices in accordance with standards. Individual measuring devices can be configured in combination with up to three associated measuring circuits and the corresponding extension modules. For more detailed technical data, please see the table on back.

	Description	Dimensions	Item no.
Leakage current measuring device	50 .. 280 VAC potential-free	19" / 4HU	92-4D
Leakage current measuring device	same with automatic current setting	19" / 4HU	92-4D Z01

## Extension options

	Technical data	for device type	Item no.
Measuring circuit	VDE 0711 / EN 60598-1	92-4D; 92-4D Z01	92-4R Z02
Measuring circuit	VDE 0750 / EN 60601	92-4D; 92-4D Z01	92-4R Z03
Measuring circuit	VDE 0805 / EN 60950	92-4D; 92-4D Z01	92-4R Z04
Measuring circuit	VDE 0860 / EN 60065	92-4D; 92-4D Z01	92-4R Z05
Measuring circuit	VDE 0411 / EN 61010	92-4D; 92-4D Z01	92-4R Z06
Measuring circuit	VDE 0700 / EN 60335-1	92-4D; 92-4D Z01	92-4R Z07
Measuring circuit	Others on request	92-4D; 92-4D Z01	
Enhancement module	Medical equipment	92-4D; 92-4D Z01	92-4R Z11
Software	On request		
Device driver	On request		
Calibration	Delivery with Elabo works calibration protocol	92-4D; 92-4D Z01	92-4D Exx*

The description of the accessories can be found in the description starting on page 108. Please also see our configuration examples on page 89. Technical specifications subject to change without notice.

## Device features 92-4D

Device	92-4D
Applications	
Manual use	●
Automated use	●
Operation	
LCD display	●
Interface	●
Start button	●
Interfaces	
RS232-C	●
Connections	
1~ socket at front	●
Laboratory receptacles at front	●
Measurement connections at back	●
Testing parameters	
Test voltage internal	50 .. 280 V
Test voltage programmable	○
Test voltage internal potential-free	●
Test current internal	0 .. 4 A
Test voltage external	50 .. 280 V
Test current external	0 .. 15 A
Frequency external	50 .. 400 Hz
Measurement range / resolution	0 .. 100 µA
Measurement error, measurement range 1 <sup>2</sup> TRMS; MAD; alternating component	1 % of meas. + 10 digit
Measurement error, measurement range 1 <sup>2</sup> Direct component; peak value	2 % of meas. + 30 digit µA
Measurement error, measurement range 2 / resolution	0 .. 1 mA
Measurement error, measurement range 2 <sup>2</sup> TRMS; MAD; alternating component	1 % of meas. + 10 digit µA
Measurement error, measurement range 1 <sup>2</sup> Direct component; peak value	2 % of meas. + 30 digit
Measurement error, measurement range 3 / resolution	0 .. 10 mA
Measurement error, measurement range 3 <sup>2</sup> TRMS; MAD; alternating component	1 % of meas. + 10 digit
Measurement error, measurement range 1 <sup>2</sup> Direct component; peak value	2 % of meas. + 30 digit
Measured bandwidth of measurement amplifier	DC; 50 Hz .. 1 MHz
Effective value measurement	● <sup>1</sup>
Average value measurement	● <sup>1</sup>
Peak value measurement	● <sup>1</sup>
AC component	● <sup>1</sup>
DC component	● <sup>1</sup>
Principal technical data	
Memory	200 data sets
Mains connection	230V ± 10 %; 49 .. 61 Hz
Dimensions	19" / 4 HU
Weight	28 kg
Allowable humidity	25 .. 75 % rel.
Working temperature	10 .. 50 °C
Test timer	1 s .. 24 h

- Standard ○ Optional

<sup>1</sup> Dependent on the testing standard applied.

Please also request the respective standards when ordering.

<sup>2</sup> Evaluated at DC / 50 .. 60 Hz

Technical specifications subject to change without notice.

# potential-free



# Testing devices and extension modules



## three-phase

<b>Technical data</b>	<b>92-4G</b>
<b>Test voltage:</b>	50 .. 480 VAC external 50 .. 480 V external
<b>Test current:</b>	0 .. 15 A 1~ • 0 .. 32 A 3~
<b>Measurement ranges:</b>	0 .. 100 µA • 0 .. 1.00 mA • 0 .. 10.0 mA
<b>Test methodology:</b>	varies accord. to standard
<b>Interface:</b>	RS232-C
<b>Line voltage:</b>	230 V ± 10 %; 49 .. 61 Hz
<b>Dimensions:</b>	19" / 4 HU
<b>Weight:</b>	20 kg



Front view 92-4G



Rear view 92-4G

### Leakage current measuring device

The testing device for measuring leakage current in three-phase units undergoing test allows the measurement of leakage current in electrical devices in accordance with norms. Individual measuring devices can be configured in combination with up to three associated measuring circuits and the corresponding extension modules. For more detailed technical data, please see the table on back.

	Description	Dimensions	Item no.
Leakage current measuring device	three-phase, external supply	19" / 4HU	92-4G

### Extension options

	Technical data	for device type	Item no.
Measuring circuit	VDE 0711 / EN 60598-1	92-4G	92-4R Z02
Measuring circuit	VDE 0750 / EN 60601	92-4G	92-4R Z03
Measuring circuit	VDE 0805 / EN 60950	92-4G	92-4R Z04
Measuring circuit	VDE 0860 / EN 60065	92-4G	92-4R Z05
Measuring circuit	VDE 0411 / EN 61010	92-4G	92-4R Z06
Measuring circuit	VDE 0700 / EN 60335-1	92-4G	92-4R Z07
Measuring circuit	Others on request	92-4G	
Extension module	Medical equipment	92-4G	92-4R Z11
Software	On request		
Device driver	On request		
Calibration	Delivery with Elabo works calibration protocol	92-4G	92-4D Exx*

The description of the accessories can be found in the description starting on page 108. Please also see our configuration examples on page 89.

\* Depending on configuration

Technical specifications subject to change without notice.

## Device features 92-4G

Device	92-4G
Applications	
Manual use	●
Automated use	●
Operation	
LCD display	●
Interface	●
Start button	●
Interfaces	
RS232-C	●
Connections	
1~ socket at front	●
3~ socket at front	●
Laboratory receptacles at front	●
Measurement connections at back	●
Testing parameters	
Test voltage external	50 .. 280 V / 50 .. 480 V
Test current external	0 .. 15 A 1~ / 0 .. 32 A 3~
Frequency external	50 .. 400 Hz
Measurement range / resolution	0 .. 100 µA
Measurement error, measurement range 1 <sup>2</sup> TRMS; MAD; alternating component	1 % of meas. + 10 digit
Measurement error, measurement range 1 <sup>2</sup> Direct component; peak value	2 % of meas. + 30 digit µA
Measurement error, measurement range 2 / resolution	0 .. 1 mA
Measurement error, measurement range 2 <sup>2</sup> TRMS; MAD; alternating component	1 % of meas. + 10 digit µA
Measurement error, measurement range 1 <sup>2</sup> Direct component; peak value	2 % of meas. + 30 digit
Measurement error, measurement range 3 / resolution	0 .. 10 mA
Measurement error, measurement range 3 <sup>2</sup> TRMS; MAD; alternating component	1 % of meas. + 10 digit
Measurement error, measurement range 1 <sup>2</sup> Direct component; peak value	2 % of meas. + 30 digit
Measured bandwidth of measurement amplifier	DC; 50 Hz .. 1 MHz
Effective value measurement	● <sup>1</sup>
Average value measurement	● <sup>1</sup>
Peak value measurement	● <sup>1</sup>
AC component	● <sup>1</sup>
DC component	● <sup>1</sup>
Principal technical data	
Memory	200 data sets
Mains connection	230 V ± 10 %; 49 .. 61 Hz
Dimensions	19" / 4 HU
Weight	20 kg
Allowable humidity	25 .. 75 % rel.
Working temperature	10 .. 50 °C
Test timer	1 s .. 24 h

# three-phase



● Standard ○ Optional

<sup>1</sup> Dependent on the testing standard applied.

Please also request the respective standards when ordering.

<sup>2</sup> Evaluated at DC / 50 .. 60 Hz

Technical specifications subject to change without notice.

# Testing devices and extension modules



## Automated version

<b>Technical data</b>	<b>90-2M</b>
Test voltage:	50 .. 280 VAC external
Test current:	0 .. 15 A
Measurement ranges:	0 .. 1.00 mA 0 .. 10.0 mA
Test methodology:	EN 60335-1
Interface:	digital • Analog output
Line voltage:	230 V ± 10%; 49 .. 61 Hz
Dimensions:	3 HU / 48 HP
Weight:	4 kg

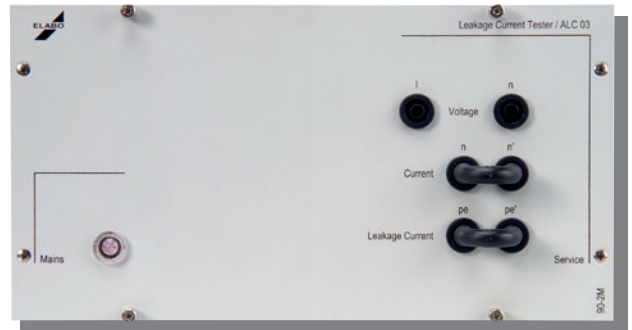

Front view 90-2M

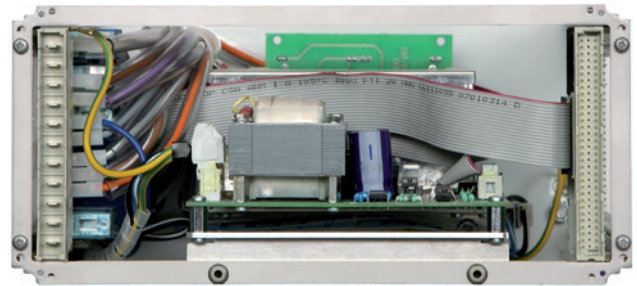

Rear view 90-2M

### Leakage current measuring device

The testing device for measuring leakage current in single- or multiple-phase units undergoing test allows the measurement of leakage current in electrical devices in accordance with EN 60335-1. A switching matrix must also be configured for the activation and selection of operating cases and faults. For more detailed technical data, please see the table on back.

	Description	Dimensions	Item no.
Leakage current measuring device	automated version, external feed, external selection	48 HP / 3 HU	90-2M

### Extension options

	Technical data	for device type	Item no.
Software	On request		
Device driver	On request		
Calibration	Delivery with Elabo works calibration protocol	90-2M	90-2M E99
Interface	Ethernet instead of digital / analog	90-2M	90-2M E10
Interface	Ethernet + RS232C instead of digital / analog	90-2M	90-2M E11
Interface	Ethernet + USB instead of digital / analog	90-2M	90-2M E12

The description of the accessories can be found in the description starting on page 108. Please also see our configuration examples on page 89. Technical specifications subject to change without notice.

## Device features 90-2M

Device	90-2M
Applications	
Manual use	
Automated use	●
Operation	
Interface	●
Interfaces	
Digital interface	●
Analog output 0 .. 10VDC (measured value)	●
Connections	
Calibration receptacles at front	●
Measurement connections at back	●
Testing parameters	
Test voltage external	50 .. 280 V
Test current external	0 .. 15 A
Frequency external	50 .. 400 Hz
Measurement range / resolution	0 .. 100 $\mu$ A
Measurement error, measurement range 1 <sup>2</sup> TRMS; MAD; alternating component	1 % of meas. + 3 $\mu$ A
Measurement error, measurement range 2 / resolution	0 .. 1 mA
Measurement error, measurement range 2 <sup>2</sup> TRMS; MAD; alternating component	1 % of meas. + 5 $\mu$ A
Measurement error, measurement range 3 / resolution	0 .. 10 mA
Measurement error, measurement range 3 <sup>2</sup> TRMS; MAD; alternating component	1 % of meas. + 50 $\mu$ A
Measured bandwidth of measurement amplifier	DC; 50 Hz .. 1 MHz
Effective value measurement	●
Principal technical data	
Mains connection	230 V $\pm$ 10 %; 49 .. 61 Hz
Dimensions	3HU / 48 HP
Weight	4 kg
Allowable humidity	25 .. 75 % rel.
Working temperature	10 .. 50 °C

# Automated version

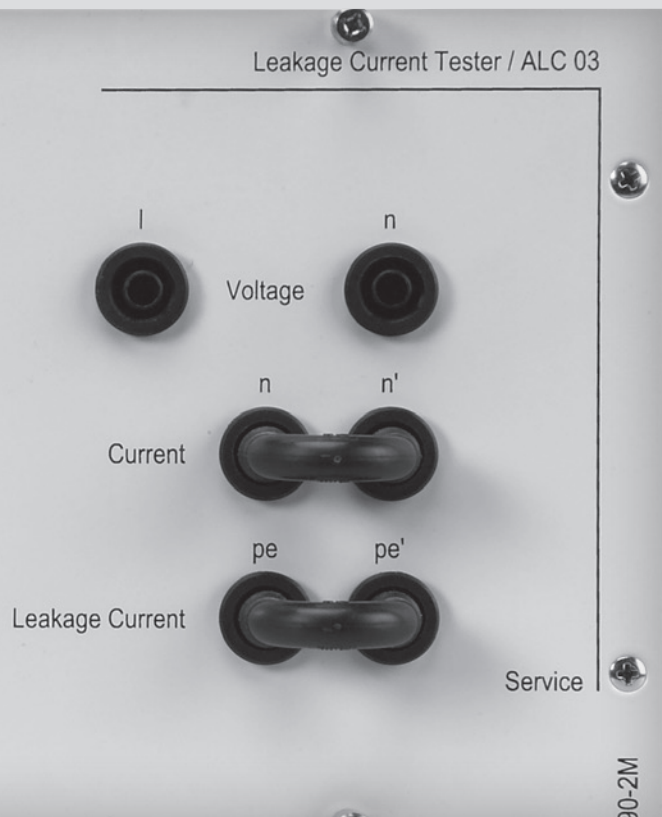

● Standard ○ Optional

<sup>1</sup> Dependent on the testing standard applied.

Please also request the respective standards when ordering.

<sup>2</sup> Evaluated at DC / 50 .. 60 Hz

Technical specifications subject to change without notice.



## Sample configurations



### Requirement:

1~ leakage current testing device with integrated voltage supply 50 .. 280 V and with measuring circuit equipped in accordance with EN60335-1. This example shows a typical configuration for this application.

Description	Quantity	Item no.
Leakage current testing device 1~	1	92-4A
Measuring circuits	1	92-4R Z07
Housing	1	93-1B
Guiding rails	1	93-1F
Calibration	1	92-4A E99

### Requirement:

1~ leakage current testing device with integrated voltage supply 50 .. 280 V and with measuring circuit equipped in accordance with EN60601 and an extension module for patient leakage current and patient auxiliary current measurement, type BF/CF. This example shows a typical configuration for this application.

Description	Quantity	Item no.
Leakage current testing device 1~	1	92-4A
"Medical" extension module	1	92-4R Z11
Measuring circuit	1	92-4R Z03
Housing	1	93-1B
Guiding rails	1	93-1F
Calibration	1	92-4A E99



### Requirement:

Leakage current testing device in accordance with EN60335-1 for use in automated systems. A 19" module rack allows the installation in a switching cabinet. You can find additional useful components such as extra blank panels in our accessories program.

Description	Quantity	Item no.
Leakage current testing device EN 60335-1	1	90-2M
Module rack with 24-pole system plug	1	94-1R
Blank panel	1	40-1D
Calibration	1	90-2M E99

# Additional measuring and testing devices

Solutions for many other applications



## Building blocks for your application

Additional measuring or power supply units are often required to construct complete measuring and testing systems. For these systems as well, Elabo offers solutions ideally tailored to your needs – using our time-tested building block system. The units listed below are examples of other modules, some of which have been developed specifically to meet customers' needs.

**Just ask us – we've got the solution.**





Whether as an individual workstation solution or as a component in a partially or fully automated testing system, in the workshop, the laboratory or in mass production – Elabo testing devices stand out because of their broad, flexible range of applications. Right from the start, the basic models of testing devices are adapted to most applications. Using appropriate accessories, they can also be customized at a later date to modified or expanded requirements, such as ongoing automation.

**Elabo – long-term reliable solutions in all cases.**



# Elabo – The complete program!



# Current-measuring/voltage-measuring modules

U • I



## threshold value module

**Technical data 90-3R**  
 Voltage measurement: 0 .. 500 V true RMS  
 Current measurement: 0 .. 5.00 A true RMS

**Technical data 90-3S**  
 Voltage measurement: 0 .. 200 V true RMS  
 0 .. 500 V true RMS

**Technical data 90-3T**  
 Current measurement: 0 .. 200 mA true RMS  
 0 .. 2.00 A true RMS

**Interface:** digital • analog output 0 .. 10 VDC  
**Frequency range:** DC / 25 .. 2000 Hz  
**Measurement uncertainty:** ± 1 % of meas.. ± 2 digit display  
**Measurement uncertainty:** ± 0.6 % of meas.. analog output  
**Line voltage:** 230 VAC ± 10 %; 49 .. 61 Hz  
**Weight:** 1 kg



Front view 90-3R



Rear view 90-3R

# Current-measuring/voltage-measuring modules

Individually configurable measuring cassettes allow the measurement of currents and voltages in test systems. The digital/analog interface allows measured values to be loaded and the measurement range to be switched. An adaptable threshold value module is available as an add-on to allow the upper and lower threshold values to be monitored without additional controls. For more detailed technical data, please see the table on back.



Front view 90-3N

	Technical data	for device type	Item no.
U/I measuring module	500 V / 5 A	24 HP / 3 HU	90-3R
Other measurement ranges	On request		
Analog output 0 .. / 4 .. 20 mA	On request		
Calibration	Delivery with Elabo works calibration protocol	90-3R	90-3R E99
Threshold value module	scalable 0 .. 1000 / 2000 / 3000 / 5000	12 HP / 3 HU	90-3N

	Technical data	for device type	Item no.
U Messmodul	200 / 500 V	24 HP / 3 HU	90-3S
Andere Messbereiche	On request		
Analog output 0 .. / 4 .. 20 mA	On request		
Calibration	Delivery with Elabo works calibration protocol	90-3S	90-3S E99
Threshold value module	scalable 0 .. 1000 / 2000 / 3000 / 5000	12 HP / 3 HU	90-3N

	Technical data	for device type	Item no.
I Messmodul	200 mA / 2 A	24 HP / 3 HU	90-3T
Andere Messbereiche	On request		
Analog output 0 .. / 4 .. 20 mA	On request		
Calibration	Delivery with Elabo works calibration protocol	90-3T	90-3T E99
Threshold value module	scalable 0 .. 1000 / 2000 / 3000 / 5000	12 HP / 3 HU	90-3N

## Device features 90-3R / 90-3S / 90-3T

Device	90-3R	90-3S	90-3T
Applications			
Manual use	● <sup>1</sup>	● <sup>1</sup>	● <sup>1</sup>
Automated use	●	●	●
Operation			
Digital display, 3.5 digits	●	●	●
Digital interface	●	●	●
Analog output 0 .. 10VDC (measured value)	●	●	●
Connections			
Measurement connections at back	●	●	●
Measurement connections at front	●	●	●
Calibration receptacles at front	●	●	●
Messbereiche			
Voltage 0 .. 199.9V		●	
Voltage 0 .. 500V	●	●	
Current 0 .. 199.9 mA			●
Current 0 .. 1.999 A			●
Current 0 .. 5.00 A	●		
Measurement error display	1 % of meas. ± 2 dig.		
Measurement error analog output	0.6 % of meas. ± 10 mV		
Measurement error analog output	>10 kΩ		
Frequency	DC / 25 .. 2.000 Hz		
Principal technical data			
Mains connection	230 V ±10 %		
Dimensions	49 .. 61 Hz		
Dimensions	3HU / 24 HP; depth 196mm		
Weight	1 kg		
Allowable humidity	25 .. 75 % rel.		
Working temperature	0 .. 50 °C		

## U • I threshold value module



Device	90-3N
Applications	
Manual use	● <sup>1</sup>
Automated use	●
Operation	
2 digital switches 4-digit	●
Digital interface	●
LED display	< = > Overflow
Analog input 0 .. 10VDC	●
Connections	
Measurement connections at back	●
Scaling ranges	
0 .. 1000	● <sup>2</sup>
0 .. 2000	● <sup>2</sup>
0 .. 3000	● <sup>2</sup>
0 .. 5000	● <sup>2</sup>
Principal technical data	
Mains connection	230 V ±10 %
Mains frequency	49 .. 61 Hz
Dimensions	3HU / 12 HP; depth 196 mm
Weight	0.5 kg
Allowable humidity	25 .. 75 % rel.
Working temperature	0 .. 50 °C

● Standard ○ Optional

<sup>1</sup> External choice of measurement range

<sup>2</sup> Scaling ranges internal selectable

The description of the accessories can be found in the description starting on page 108.

Technical specifications subject to change without notice.

# Digital multimeter

Technical data	<b>41-1N</b>
Voltage measurement	0 .. 750 VAC 0 .. 1.000 VDC
Current measurement	0 .. 20 AAC 0 .. 20 ADC
Resistance measurement	0 .. 0.2 / 2 / 20 / 200 k $\Omega$ 2 / 20 M $\Omega$
Temperature measurement	- 100 .. + 250°C
Frequency measurement	0 .. 50 kHz
Diod / continuity measurement	3V / 1 mA



Front view 41-1N

## Digital multimeter

With the fully interfaceable digital multimeter it is possible to measure voltage, current, resistance, temperature and frequency values in test systems. In addition, diode/continuity measurements can also be carried out. The optional interface permits measurement data to be read into a software-controlled testing system.

	Technical data	Dimensions	Item no.
Digital multimeter	U, I, R, T, f	24 HP / 3 HU	41-1N

### Extension modules for the test device

	Technical data	For device type	Item no.
Ethernet	Ethernet-Interface	41-1N	N3-4P Z102
RS232C	RS232-Interface	41-1N	N3-4P Z101
USB	USB-Interface	41-1N	N3-4P Z103

The description of the accessories can be found in the description starting on page 108. Technical specifications subject to change without notice.

# Device features 41-1N

Device	41-1N
Applications	
Display	LCD with blue backlight
Readout	Digital display 5.5 digits
Interface Ethernet	○
Interface RS232C	○
Interface USB	○
Operator buttons	●
Connections	Laboratory receptacles on front
Principal technical data	
Mains connection	230V +10 / - 5 %
Mains frequency	49 .. 61 Hz
Dimensions	3 HU / 24 HP depth 120 mm
Weight	1 kg
Allowable humidity	25 .. 75 % rel.
Working temperature	0 .. 40°C
Warm-up time	ca. 10 Min.

- Standard ○ Optional

The description of the accessories can be found in the description starting on page 108.

Technical specifications subject to change without notice.



Measurement range	Resolution	Accuracy of meas. at 5 .. 100 % of measurement range			
		DC AC 40 .. 500 Hz	AC 20 .. 40 Hz	AC 0.5 .. 10 kHz	AC 10 .. 20 kHz
<b>Voltage measurement DC</b>					
200 mV	0.01 mV	± 0.05 % ± 4 dig.			
2 V	0.000 1V				
20 V	0.001 kV				
200 V	0.001 kV				
1.000 V	0.00001 kV				
<b>Current measurement DC</b>					
200 μA	0.0001 mA	± 0.2 % ± 2 dig.			
2 mA	0.0001 mA				
20 mA	0.0001 mA				
200 mA	0.001 mA				
2 A	0.0001 A				
20 A	0.01 A	± 0.7 % ± 2 dig.			
<b>Voltage measurement AC</b>					
200 mV	0.01 mV	± 0.05 % ± 1 dig.	± 0.7 % ± 1 dig.	± 1 % ± 1 dig.	± 3.25 % ± 1 dig.
2 V	0.000 1V				
20 V	0.001 kV				
200 V	0.001 kV				
1.000 V	0.00001 kV				
<b>Current measurement AC</b>					
200 μA	0.0001 mA	± 0.7 % ± 5 dig.	± 1 % ± 4 dig.	± 1 % ± 1 dig. (up to 2 kHz)	
2 mA	0.0001 mA				
20 mA	0.0001 mA				
200 mA	0.001 mA				
2 A	0.0001 A				
20 A	0.01 A	± 0.9 % ± 5 dig.			
<b>Resistance measurement</b>					
200 Ω	0.01 Ω	± 0.2 % ± 3 dig.			
2 kΩ	0.0001 Ω				
20 kΩ	0.0001 kΩ				
200 kΩ	0.001 kΩ				
2 MΩ	0.00001 MΩ				
20 MΩ	0.0001 MΩ	± 1.5 % ± 3 dig.			
<b>Temperature measurement</b>					
-100 .. + 250 °C	0.1 °	± 1 % ± 1 dig.			
<b>Frequency measurement</b>					
50 kHz	0.1 Hz	± 0,1% of meas. ± 1 dig.			



# High-voltage multimeter with HV load unit



Technical data	<b>94-8A</b>
AC HV measurement	100 .. 7.070 VAC true RMS with DC coupling
DC HV measurement	± 100 .. 10000 VDC
Current measurement:	0.2 .. 100 mA
Measurement uncertainty:	± 0.2% of meas. ± 2 digit
Line voltage:	230 VAC ± 10%; 49 .. 61 Hz
Technical data	<b>94-8R</b>
Resistances:	5 / 10 / 100 / 500 kΩ 1 / 5 MΩ
Weight:	2.6 • 1.6 kg



Front view 94-8A

## High-voltage multimeter with load unit

These units were specially designed for calibrating the current and voltage measurement systems of high-voltage testing devices. The data of the measuring unit are taken from PTB standards. The device can easily be plugged into the testing device to be calibrated using the cable included. The optional load unit allows the data to be logged under actual load conditions. For more detailed technical data, please see the table on back.



Front view 94-8R

	Description	Dimensions	Item no.
High-voltage multimeter	incl. 2 m high-voltage connecting line	W = 260; H=160; D=260 mm	94-8A
Load unit	incl. set of connection cables	W = 260; H=70; D=260 mm	94-8R

### Extension modules for the testing devices

	Technical data	for device type	Item no.
DKD calibration certificate		94-8A	94-8F

The description of the accessories can be found in the description starting on page 108.  
Technical specifications subject to change without notice.

## Device features 94-8A / 94-8R

Device	94-8A		
Applications			
Manual use	●		
Automated use			
Operation			
Digital display	4.5 digits		
Switch AC/DC	●		
Switch U/I	●		
Measurement socket on back	●		
Load socket on front	●		
Autorange	●		
Measuring ranges DC	TRMS with DC coupling		
Measurement	Measurement	Resolution	Accuracy
Voltage range 1	±0.1 .. 1.0000 kV	0.1 V	±0.2 % of meas. ±2 dig. <sup>1</sup>
Voltage range 2	±0.1 .. 10.000 kV	1.0 V	
Current range 1	±0.2 .. 10.000 mA	1.0 µA	
Current range 2	±0.2 .. 100.00 mA	10.0 µA	
Measuring ranges AC	Arithmetic Mean		
Measurement	Measurement	Resolution	Accuracy
Voltage range 1	0.1 .. 0.330 kV	0.1 V	±0.2 % of meas. ±2 dig. <sup>1</sup>
Voltage range 2	0.1 .. 1.0000 kV	0.1 V	
Voltage range 3	0.1 .. 3.3000 kV	1.0 V	
Voltage range 4	0.1 .. 7.070 kV	1.0 V	
Current range 1	0.2 .. 3.300 mA	1.0 µA	
Current range 2	0.2 .. 10.000 mA	1.0 µA	
Current range 3	0.2 .. 33.00 mA	10.0 µA	
Current range 4	0.2 .. 100.00 mA	10.0 µA	
Principal technical data			
Mains connection	230 V ±10 %		
Mains frequency	49 .. 61 Hz		
Dimensions	Height 160; Width 260; Depth 260 mm		
Weight	2.6 kg		
Allowable humidity	25 .. 75 % rel.		
Working temperature	0 .. 40 °C		



Device	94-8R		
Applications			
Ranges	jumper		
Cable on back	●		
Resistance ranges			
	Resistance	Accuracy	max. power load
Resistor 1	5 kΩ 5 % 50 W	0.1 V	±0.2 % of meas. ±2 dig. <sup>2</sup>
Resistor 2	10 kΩ 25 W	1.0 V	
Resistor 3	100 kΩ 10 W	1.0 µA	
Resistor 4	500 kΩ 12.5 W	10.0 µA	
Resistor 5	1 MΩ 9 W	10.0 µA	
Resistor 6	5 MΩ 5 W	10.0 µA	
Principal technical data			
Measurement time	Max. 2 Min.		
Cooling time	Min. 5 Min.		
Dimensions	Height 70; Width 260; Depth 260 mm		
Weight	1.6 kg		
Allowable humidity	25 .. 75 % rel.		
Working temperature	0 .. 40 °C		

- Standard    ○ Optional

<sup>1</sup> Evaluated at 50/60 Hz

Technical specifications subject to change without notice.

# Resistance measuring devices



<b>Technical data</b>	<b>92-5K</b>
<b>Measurement ranges:</b>	200 mΩ 2 • 20 • 200 Ω 2 • 200 • 2000 kΩ
<b>Temperature compensation:</b>	- 50 .. + 250°C
<b>Measurement error:</b>	0.1% of meas. + 0.05% of meas./K + 2 digit
<b>Measurement current:</b>	100 mA .. 1 μA
<b>Measuring rate:</b>	max. 3/s
<b>Interface:</b>	RS232-C
<b>Line voltage:</b>	230 VAC ± 10%; 49 .. 61 Hz
<b>Weight:</b>	3 kg

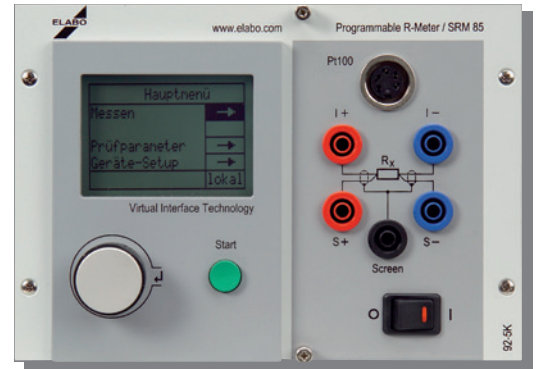

Frontansicht 92-5K



Rückansicht 92-5K

## Resistance measuring device

The unit is for measuring resistance and temperature using 4-wire technology. The measured resistance value in combination with the temperature measurement can be mathematically standardized at a selectable temperature. The unit can be operated manually via a rotary pulse encoder on the front panel as well as via the interface. The menu functions, parameters and measured data are displayed on an easy-to-read LC graphic display. Up to 300 test parameter sets can be saved in the internal memory. For more detailed technical data, please see the table on back.

	Description	Dimensions	Item no.
Resistance measuring device	Incl. LC display and rotary encoder	36 HP / 3 HU	92-5K

### Extensions and accessories for the testing device

	Technical data	for device type	Item no.
Calibration	Elabo works calibration certificate	92-5K	92-5K E99
Measurement lines	With Kelvin clamps for 4-wire technology 1.5 m	92-5K	94-5A
Temperature probe	PT100 sensor element	92-5K	94-5B
Housing			30-6M

The description of the accessories can be found in the description starting on page 108. Technical specifications subject to change without notice.



# Device features 92-5K

Device	92-5K		
Applications			
Manual use	●		
Automated use	●		
Operation			
Readout	LCD 128x64 Pixel		
User Interface	rotary encoder		
Interface	RS232-C		
Digital interface	●		
Start button	●		
Load socket on front	Min / Max		
Connections			
Measurement connection on front	●		
Measurement connection at back	●		
Shield connection on front	●		
RS232-C at back	●		
PT100 on front	●		
Measurement ranges			
Method of measurement	4-wire-measurement		
Temperature compensation	Cu, Fe, Al, var.		
Measuring current	1 $\mu$ A .. 100 mA		
	Measurement	Resolution	Accuracy
Measurement range 1	200 m $\Omega$	0,1 m $\Omega$	0,1 % of meas. +0,05 % of meas./K +2 dig.
Measurement range 2	2 $\Omega$	1 m $\Omega$	
Measurement range 3	20 $\Omega$	10 m $\Omega$	
Measurement range 4	200 $\Omega$	0,1 $\Omega$	
Measurement range 5	2 k $\Omega$	1 $\Omega$	
Measurement range 6	20 k $\Omega$	10 $\Omega$	
Measurement range 7	200 k $\Omega$	0,1 k $\Omega$	
Measurement range 8	2 M $\Omega$	1 k $\Omega$	
Principal technical data			
Mains connection	230 V $\pm$ 10 %		
Mains frequency	49 .. 61 Hz		
Dimensions	3 HU / 24 HP / depth 196 mm		
Weight	3 kg		
Allowable humidity	25 .. 75 % rel.		
Working temperature	10 .. 50 $^{\circ}$ C		
Memory	300 data sets		
Measurement speed	Max. 3 measurements / s		
Resolution	12 Bit		

● Standard    ○ Optional

Technical specifications subject to change without notice.



# Resistance measuring devices



<b>Technical data</b>	<b>90-3K</b>
<b>Measurement ranges:</b>	200 mΩ 2 • 20 • 200 Ω 2 • 20 • 200 • 2000 kΩ
<b>Measurement error:</b>	0.2% of meas. + 0.03% of meas./K + 1 digit
<b>Measurement current:</b>	100 mA .. 1 μA
<b>Measuring rate:</b>	35 .. 300 ms 2.5 s in the 2 MΩ range
<b>Interface:</b>	digital • Analog output
<b>Line voltage:</b>	230 VAC ± 10%; 49 .. 61 Hz
<b>Weight:</b>	1.8 kg



Front view 90-3K



Rear view 90-3K

## Resistance measuring device

The unit permits the measurement of resistance using 4-wire technology and is suitable both for individual use in manufacturing, laboratories and receiving inspections as well as for use in automated test systems. The measurement ranges can be preselected using digital 24 V DC signals. Measured data are available as analog voltages (0- 10 V). For more detailed technical data, please see the table on back.

	Description	Dimensions	Item no.
Resistance measuring device		36 HP / 3 HU	90-3K

### Extensions and accessories for the testing device

	Technical data	for device type	Item no.
Calibration	Elabo works calibration certificate	90-3K	90-3K E99
Measurement lines	With Kelvin clamps for 4-wire technology 1.5 m	90-3K	94-5A
Housing			30-6M

The description of the accessories can be found in the description starting on page 108. Technical specifications subject to change without notice.

# Device features 90-3K

Device	90-3K		
Applications			
Manual use	●		
Automated use	●		
Operation			
Readout	3.5 digits		
Measurement range switch	●		
Digital interface	●		
Analog output	●		
Connections			
Measurement connection on front	●		
Measurement connection at back	●		
Measurement ranges			
Method of measurement	4-wire-measurement		
Measuring current	1 $\mu$ A .. 100 mA		
	Measurement	Resolution	Accuracy
Measurement range 1	200 m $\Omega$	100 $\mu$ $\Omega$	0.2 % of meas. +0.03 % of meas./K +1 dig.
Measurement range 2	2 $\Omega$	1 m $\Omega$	
Measurement range 3	20 $\Omega$	10 m $\Omega$	
Measurement range 4	200 $\Omega$	100 m $\Omega$	
Measurement range 5	2 k $\Omega$	1 $\Omega$	
Measurement range 6	20 k $\Omega$	10 $\Omega$	
Measurement range 7	200 k $\Omega$	100 $\Omega$	
Measurement range 8	2 M $\Omega$	1 k $\Omega$	
Principal technical data			
Mains connection	230 V $\pm$ 10 %		
Mains frequency	49 .. 61 Hz		
Dimensions	3HU / 24 HP / Tiefe 196 mm		
Weight	3 kg		
Allowable humidity	25 .. 75 % rel.		
Working temperature	10 .. 50 $^{\circ}$ C		
Measuring speed	35 ms:		
	2 $\Omega$ ; 20 $\Omega$ ; 200 $\Omega$ ; 2 k $\Omega$ ; 20 k $\Omega$		
	300 ms: 200 m $\Omega$ ; 200 k $\Omega$		
	2500 ms: 2 M $\Omega$		

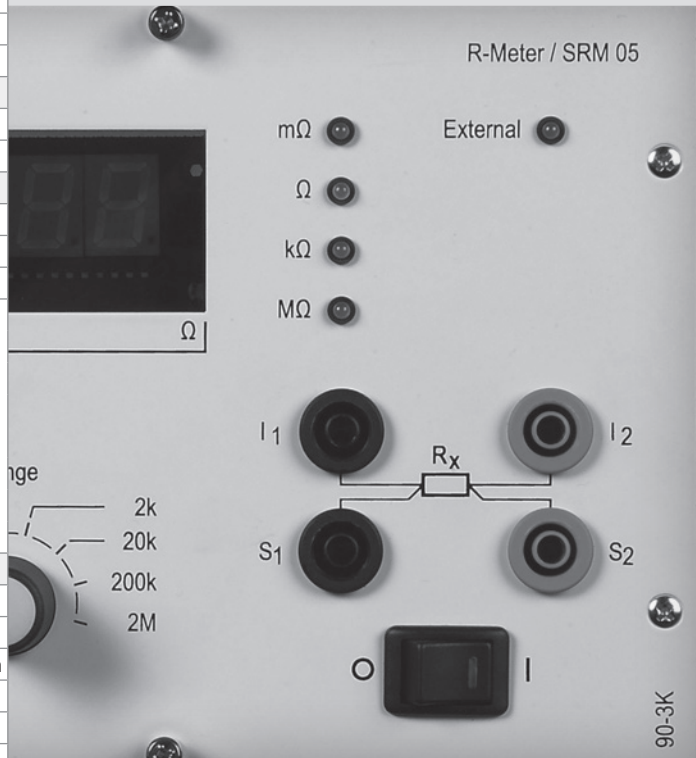

● Standard    ○ Optional

Technical specifications subject to change without notice.



## AC regulator

Technical data	<b>90-7A / 90-7B</b>
Output voltage:	0 .. 265 VAC
Frequency:	50 Hz
Power:	1000 VA / 3500 VA
Deviation:	± 1% of setting
Adjustment:	electromechanical
Adjustment speed:	max. 50 V/s
Load:	fully inductive/capacitive
Interface:	digital • Analog interface
Line voltage:	230 VAC ± 10%; 49 .. 61 Hz
Weight:	90-7A: 17 kg 90-7B: 31 kg



Front view 90-7A



Front view 90-7B

### Regulated AC voltage supply

The unit provides a stable voltage supply to consumers. The unit can be operated manually at the front panel as well as via the interface. Measured data are displayed on digital instruments. For more detailed technical data, please see the table on back.

	Description	Dimensions	Item no.
AC voltage supply	1000 VA programmable	19" / 4HU	90-7A
AC voltage supply	3500 VA programmable	19" / 8HU	90-7B

### Extensions for the testing devices

	Technical data	for device type	Item no.
Interface	On request	90-7A	
Interface	On request	90-7B	
Other voltage ranges	On request		
Other current ranges	On request		
Calibration	Elabo works calibration	90-7A	90-7A E99
Calibration	Elabo works calibration	90-7B	90-7B E99

The description of the accessories can be found in the description starting on page 108. Technical specifications subject to change without notice.

## Device features 90-7A / 90-7B

Device	90-7A	90-7B
Applications		
Manual use	●	●
Automated use	●	●
Operation		
Digital display	●	●
Potentiometer for setting	●	●
Range selector switch at front		
Fuses at front	●	●
Power switch at front	●	●
Digital interface	●	●
Analog input 0 .. 10 VDC (setting)	●	●
Connections		
Socket on front	●	●
Laboratory receptacles at front	●	●
Output voltage		
Voltage range 1	0 .. 135 V	
Voltage range 2	0 .. 265 V	
Current	0 .. 4 A	0 .. 15 A
Max. Power	1000 VA	3500 VA
Frequency	Mains	
Principal technical data		
Mains connection	230 V ±10 %	
Mains frequency	49 .. 61 Hz	
Dimensions – depth 360 mm	19" / 4 HU	19" / 8 HU
Weight	17 kg	31 kg
Allowable humidity	25 .. 75 % rel.	
Working temperature	10 .. 40 °C	
Adjustment speed	Max. 50 V/s	
Deviation of adjustment	± 1 % of Setting	

# AC regulator



● Standard    ○ Optional  
 Technical specifications subject to change without notice.



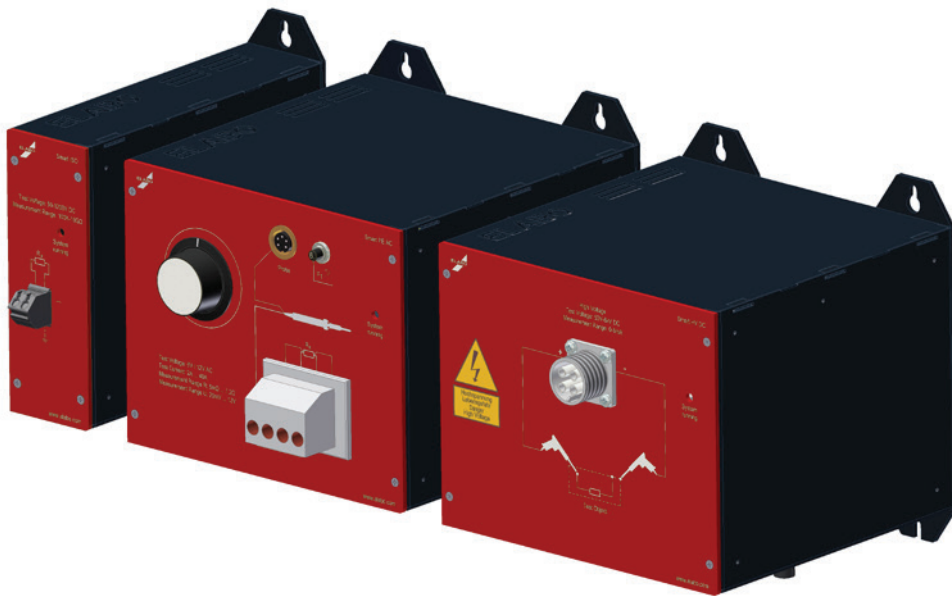

# fully electronic

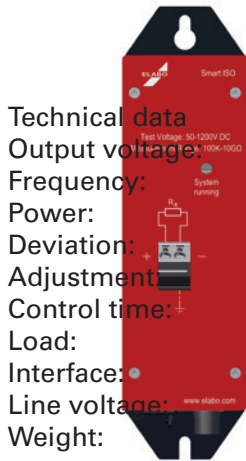

<b>Technical data</b>	<b>90-7F / 90-7G</b>
<b>Output voltage:</b>	0 .. 135 • 265 VAC
<b>Frequency:</b>	45 .. 400 Hz
<b>Power:</b>	220 / 500 VA
<b>Deviation:</b>	± 0.2% of meas.
<b>Adjustment:</b>	fully electronic
<b>Control time:</b>	max. 400 ms
<b>Load:</b>	fully inductive/capacitive
<b>Interface:</b>	digital • Analog interface
<b>Line voltage:</b>	230 VAC ± 10%; 49 .. 61 Hz
<b>Weight:</b>	90-7F: 24 kg 90-7G: 36 kg

Front view 90-7F

## Fully electronic AC voltage supply

The unit provides a stable, frequency-controlled voltage supply to consumers. The unit can be operated manually at the front panel as well as via the interface. Current, voltage and frequency are displayed on digital instruments. Frequency is displayed on a four-digit digital display. For more detailed technical data, please see the table on back.

Front view 90-7G

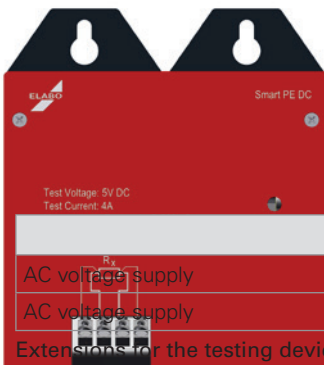

	Description	Dimensions	Item no.
AC voltage supply	220 VA fully electronic	19" / 4HU	90-7F
AC voltage supply	500 VA fully electronic	19" / 6HU	90-7G
<b>Extensions for the testing devices</b>			
	Technical data	for device type	Item no.
Interface	On request	90-7F	
Interface	On request	90-7G	
Other voltage ranges	On request		
Other current ranges	On request		
Calibration	Elabo works calibration	90-7F	90-7F E99
Calibration	Elabo works calibration	90-7G	90-7G E99

The description of the accessories can be found in the description starting on page 108. Technical specifications subject to change without notice.

## Device features 90-7F / 90-7G

Device	90-7F	90-7G
<b>Applications</b>		
Manual use	●	●
Automated use	●	●
<b>Operation</b>		
Digital display voltage 3 digits	●	●
Digital display frequency 4 digits	●	●
Potentiometer for voltage setting	●	●
Potentiometer for frequency setting	●	●
Fuses at front	●	●
Power switch at front	●	●
Digital interface	●	●
Analog input 0 .. 10 VDC (setting)	●	●
<b>Connections</b>		
Socket on front	●	●
Laboratory receptacles at front	●	●
<b>Output voltage</b>		
Voltage range 1	5 .. 135 V	
Current range 1	0 .. 1.63 A	0 .. 3.7 A
Voltage range 2	5 .. 265 V	
Current range 2	0 .. 0.83 A	0 .. 1.88 A
Max. Power	220 VA	500 VA
Frequency	45 .. 400 Hz	
<b>Principal technical data</b>		
Mains connection	230 V ±10 %	
Mains frequency	49 .. 61 Hz	
Dimensions – depth 360 mm	19" / 4 HU	19" / 6 HU
Weight	24 kg	36 kg
Allowable humidity	25 .. 75 % rel.	
Working temperature	10 .. 45 °C	
Adjustment speed	Max. 400 ms	
Deviation of adjustment	± 0.2 % of meas.	

- Standard      ○ Optional

Technical specifications subject to change without notice.

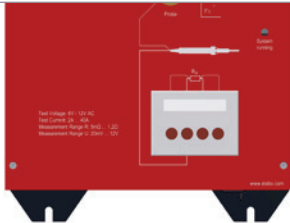

# Direct current voltage supplies

an extensive range of devices

In addition to the AC voltage supply systems contained in this catalogue, Elabo also has an extensive range of DC voltage supplies to offer.

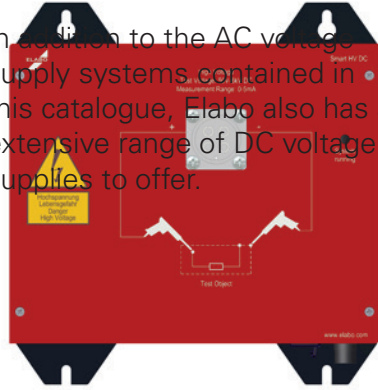

### Performance features:

- Master-slave operation
- Parallel operation (0-4 A)
- Serial operation (0-60 V)
- Tracking operation ( $\pm 30$  V)
- Pre-defined curve patterns- sinusoidal, rectangular, triangular, sawtooth, PWM
- Arbitrary function for free programming of voltage and current curves
- Output limitation, password-protected
- Predefined start-up values
- Ethernet and USB interface
- Integrated Web-Server for simple remote control by means of a web browser

### Special feature: Arbitrary function

The laboratory power supply devices have an arbitrary function that makes it possible to program and run pre-determined functions or freely definable voltage and current curves.

The optional functions available are: sinusoidal, rectangular, triangular, sawtooth, PWM.

Up to 6 curves with 99 support points each can be programmed in the freely programmable mode. In all cases, the initial value and the end value for current and voltage, and also the time duration, are pre-set. In the automatic and digital versions, the arbitrary function can be used only via an interface.

Power class	120 W	300 W	600 W	600 W	1200 W	1200 W
Output						
Voltage	2 x 0- 30 V	0- 30 V	0- 60 V	0- 30 V	0- 30 V	0- 300 V
Current	2 x 0- 2 A	0- 10 A	0- 10 A	0- 20 A	0- 40 A	0- 4 A
Dimensions	3 HU / 42 HP Depth 196mm	3 HU / 66 HP Depth 196mm	6 HU / 2WU Depth 260mm	6 HU / 4WU Depth 260mm	6 HU / 4WU Depth 260mm	6 HU / 4WU Depth 260mm

You can request our current **Elabo Electronics** catalogue directly by calling **+49 7951 307- 0**. In addition to the power supply systems, the catalogue contains a wide range of devices for your electrical/electronics laboratory.



# Accessories

Tailor-made add-on solutions



## Elabo – complete

The requirements placed on testing equipment are often very different. But all of them must always be optimally fulfilled. Therefore, we offer you a comprehensive accessory program that will ensure you are always prepared for any situation.



## Elabo – expandable

Our products are designed and constructed so that all devices can be expanded at a later date. The advantage to you is that you make investments when they are really required.



## Elabo – individually tailored

Don't see what you need?  
Ask us! We will meet your very specific requirements.

### Elabo – details

When designing our testing devices we pay attention to the smallest details, e.g. to ensure adaptable solutions ideally customized to the application. But we are just as careful when it comes to our accessories, so that you always get what's best for you.

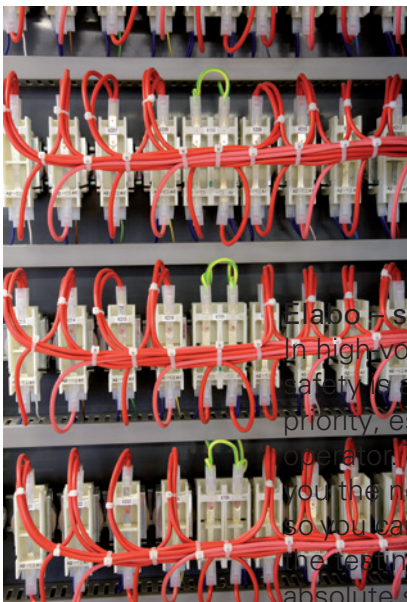

### Elabo – safety

In high-voltage testing, safety is always our top priority, especially for the operator. Therefore, we offer you the necessary accessories so you can always perform the testing process in absolute safety.





# Accessories – housings

## Housing cassettes



Portable aluminum housings turn cassette devices into easy-to-handle modules. The housings are robust, powder-coated and are fitted with handles. Our housings have a rear panel with an integrated IEC connector for connection to the power supply. Delivery includes a 2.5 m connection cable. Additional pluggable interface connectors can be installed on request.

Technical data	Dimensions	Item no.
24 HP / 3 HU	W=170; D=285; H=150 mm	30-6L
36 HP / 3 HU	W=230; D=285; H=150 mm	30-6M
42 HP / 3 HU	W=260; D=285; H=150 mm	30-6P
84 HP / 3 HU	W=475; D=285; H=150 mm	30-6N
84 HP / 3 HU	W=475; D=285; H=150 mm Wiring prepared for dual PE/IR measurement	30-6R

## Module rack

Module racks enable the installation of, for example, 3 HU measuring cassettes in 19" housings or racks. The racks consist of anodized side panels with front and side profiles including M 2.5 threaded strips. Guiding rails for euroboards or measuring cassettes can be engaged in predrilled holes.



Technical data	Dimensions	Item no.
84 HP / 3 HU	W=483; D=280; H=133 mm No wiring or plug connectors	51-4A
84 HP / 3 HU	W=483; D=360; H=133 mm No wiring or plug connectors	94-1R
84 HP / 3 HU	W=483; D=360; H=133 mm Incl. 24-pole plug connector built into back. No wiring	94-1R Z01
84 HP / 3 HU	W=483; D=360; H=133 mm Wiring prepared for dual PE/IR measurement, incl. 24-pole plug connector built into back	94-1T
2 x 84 HP / 3 HU	W=483; D=360; H=266 mm Incl. 24-pole plug connector built into back	94-1S
Jack plate incl. 24-pole plug connector for installation in 19" racks (e.g. for 94-1R).		93-1M
Guiding rails, plug connector, wiring		On request

## Blank panels

Blank aluminum panels serve to close off open installation spaces in housings or module racks. The 2.5 mm aluminum panels are powder-coated (similar to RAL 7035). An M5 grounding bolt is welded onto the back of the blank panel.

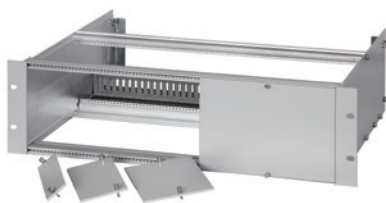

Technical data	Dimensions	Item no.
4 HP	W=20.3; H=128.5 mm	40-1H
6 HP	W=30.4; H=128.5 mm	40-1G
8 HP	W=40.3; H=128.5 mm	40-1J
12 HP	W=60.9; H=128.5 mm	40-1A
18 HP	W=91.4; H=128.5 mm	40-1B
24 HP	W=121.9; H=128.5 mm	40-1C
36 HP	W=182.9; H=128.5 mm	40-1D
42 HP	W=213.9; H=128.5 mm	40-1E
48 HP	W=243.8; H=128.5 mm	40-1F
60 HP	W=304.8; H=128.5 mm	40-1K
84 HP	W=487.6; H=128.5 mm	40-1L

Technical specifications subject to change without notice.



## Housing for 19" devices; depth 390 mm



Plug-in module housings make 19" plug-in devices easy to handle. Guiding rails and blank panels complete the housings to meet your needs. The sheet metal housings are robust, powder-coated and fitted with fold-away handles. The housing has no rear panel so that the original rear panel of the plugged-in device is directly accessible.

Technical data	Dimensions	Item no.
19" / 3 HU	W= 520; D=390; H=170mm	93-1A
19" / 4 HU	W= 520; D=390; H=215mm	93-1B
19" / 6 HU	W= 520; D=390; H=305mm	93-1C
19" / 8 HU	W= 520; D=390; H=395mm	93-1D
19" / 12 HU	W= 520; D=390; H=570mm	93-1E
19" / 16 HU	W= 520; D=390; H=750mm	93-1G

## Housing for 19" devices; depth 600 mm



This deeper housing model enables the installation of additional components or wiring behind the device plane. Additional blank panels must be installed to close off the back of the housing.

Technical data	Dimensions	Item no.
19" / 4 HU	W= 520; D=600; H=215mm	93-2B
19" / 6 HU	W= 520; D=600; H=305mm	93-2C
19" / 8 HU	W= 520; D=600; H=395mm	93-2D
19" / 12 HU	W= 520; D=600; H=570mm	93-2E
19" / 16 HU	W= 520; D=600; H=750mm	93-2G

## Guiding rails

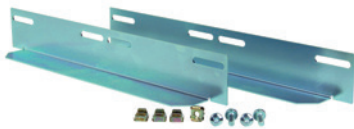

Technical data	Item no.
1 pair of guiding rails, length 340 mm for sheet metal housings 390 mm deep. Made of chromatinized sheet metal, fastening materials included. A set of guiding rails is required for each plug-in module.	93-1F
1 pair of guiding rails, length 360 mm for sheet metal housings 600 mm deep. Made of chromatinized sheet metal, fastening materials included. A set of guiding rails is required for each plug-in module.	93-2F

## Blank panels



Blank aluminum panels serve to close off open installation spaces in housings or racks. The 3 mm aluminum panels are powder-coated (similar to RAL 7035). An M5 grounding bolt is welded onto the back side of the blank panel.

Technical data	Item no.
19" / 1 HU	51-1A
19" / 1 HU with ventilation slots	51-1L
19" / 2 HU	51-1B
19" / 3 HU	51-1C
19" / 4 HU	51-1E
19" / 6 HU	51-1D
19" / 8 HU	51-1F

# Mobile test units

## Mobile test unit



Elabo offers an extensive range of mobile test units for any purpose. Our building block system allows the mobile unit to be custom designed for your needs. The following configurations are examples.

Technical data	Item no.
<p>Elabo mobile test unit accommodating 19" testing devices and corresponding accessories.</p> <p>Equipment:</p> <ul style="list-style-type: none"> <li>- TaMo basic mobile unit 1100 mm</li> <li>- Drawer element</li> <li>- Rack base</li> <li>- shelf element</li> <li>- Test probe holder</li> <li>- Cable holder</li> </ul> <p>The depicted test device, test probes as well as the housing has to be ordered separately.</p>	T0-1T Z10



You can order our current **TaMo** catalog directly by calling **+49 7951 307-0**.

Technical data	Item no.
<p>Elabo mobile test unit accommodating 19" testing devices and corresponding accessories.</p> <p>Equipment:</p> <ul style="list-style-type: none"> <li>- TaMo basic mobile unit 1600 mm</li> <li>- Drawer element</li> <li>- Rack base</li> <li>- Test probe holder</li> <li>- Function rack covers</li> <li>- Brush strips</li> <li>- Cable holder</li> </ul>	T0-1T Z12
<p>Elabo mobile test unit accommodating 19" testing devices and corresponding accessories.</p> <p>Equipment:</p> <ul style="list-style-type: none"> <li>- TaMo basic mobile unit 1600 mm</li> <li>- Drawer element</li> <li>- Rack base</li> <li>- Traverse incl. TFT-holder</li> <li>- Test probe holder</li> <li>- Cable holder</li> <li>- Function rack covers</li> <li>- Brush strips</li> <li>- Keyboard sweep</li> <li>- Shelf element</li> <li>- Board strip</li> </ul> <p>The illustrated components such as test device, PC panel, housing, printer, keyboard, PE test probe, two-hand control and warning light set must be ordered separately.</p>	T0-1T Z13

Technical specifications subject to change without notice.



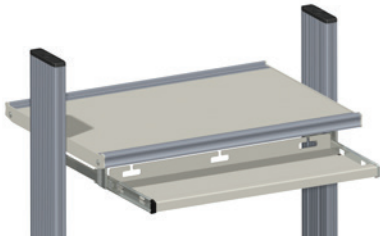
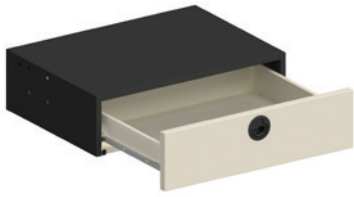
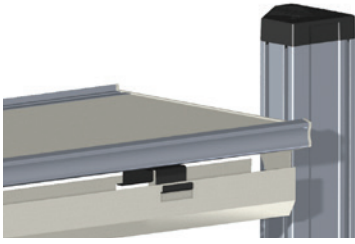

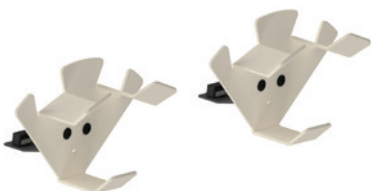
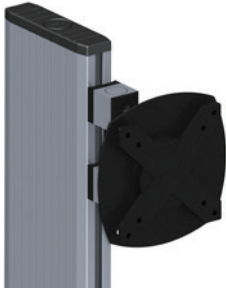

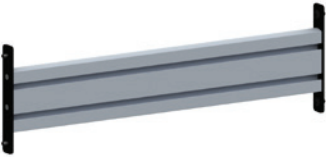

# Accessories – high voltage

## Test probe



Elabo safety test probe with high-voltage cable and special high-voltage plug. The test probe is rated for a voltage of 8kV AC / 10 kV DC. If the testing device is operated with an adapter cable, a hand-held start button is required in addition to the test probe.

Technical data	for device type	Item no.
Cable length: 2 m, 1 pc	High-voltage testing devices <sup>1</sup> / Combi-	94-2A Z02m-1Stk
Cable length: 4 m, 1 pc.	High-voltage testing devices <sup>1</sup> / Combi-	94-2A Z04m-1Stk
Cable length: 6 m, 1 pc.	High-voltage testing devices <sup>1</sup> / Combi-	94-2A Z06

## Test probe



Elabo safety test probes with high-voltage cables and special high-voltage plugs. The test probes are rated for a voltage of 8 kV AC / 10 kV DC.

Technical data	for device type	Item no.
Cable length: 2 m, 2 pc.	High-voltage testing devices <sup>1</sup> / Combi-tester	94-2A
Cable length: 4 m, 2 pc.	High-voltage testing devices <sup>1</sup> / Combi-tester	94-2A Z04m
Cable length: 6 m, 2 pc.	High-voltage testing devices <sup>1</sup> / Combi-tester	94-2A Z06m

## Connecting cables



Elabo high-voltage connecting cables with special high-voltage plug connectors. Different connector sockets are incorporated in the devices depending on the device version. Please therefore observe the "For device type" column when selecting.

Technical data	for device type	Article no.
Cable length: 2 m, 2 items	High-voltage testing devices <sup>1</sup> / Combi-tester	94-2B
Cable length: 4 m, 2 items	High-voltage testing devices <sup>1</sup> / Combi-tester	94-2B Z04m
Cable length: 6 m, 2 items	High-voltage testing devices <sup>1</sup> / Combi-tester	94-2B Z06m
Cable length: 10 m, 2 items	High-voltage testing devices <sup>1</sup> / Combi-tester	94-2B Z10m
Cable length: 2.5 m, 2 items	F1-1C, F1-1P	94-2B ZF1-1C
Cable length: 2.5 m, 2 items	F1-1D, F1-1Q	94-2B ZF1-1D

## Warning lights



Hazard indication is essential at the test station in accordance with EN50191. Elabo warning lights can be connected to all testing devices and thus signal the hazard area.

Technical data	for device type	Item no.
Table-top housing with connection plug Cable length: 2.5 m	High-voltage testing devices/ Combi-testers	94-2C
Signal column with magnetic foot and connection plug Cable length: 2.5 m	High-voltage testing devices/ Combi-testers	F9-1A

## Two-hand control device

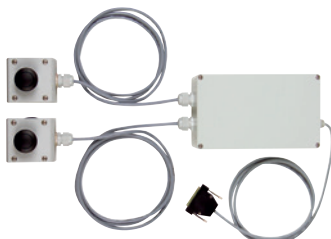

In accordance with EN 50191, when using testing lines with fixed attachments, the use of a two-hand control device in accordance with EN 574 Type IIIC and EN 354-1 at the test station is essential. The safety two-hand relay consists of an analysis unit and two separate press buttons. The unit can be connected directly to Elabo high-voltage testing devices.

Technical data	for device type	Item no.
Analysis unit with connection plug and two connected control buttons, cable length: 2.5 m	High-voltage testing devices/ Combi-testers	F9-1L-01
Mounting kit for TaMo test units	T0-1T Z12. T0-1T Z13	T3-6G

<sup>1</sup> not for test devices F1-1C; F1-1P; F1-1D; F1-1Q  
Technical specifications subject to change without notice.

## Accessories – high voltage

### Foot switch



If a high-voltage test is performed using two test probes, the test can be started ergonomically using a foot switch. Secure contact is first made with the object being tested before the test is started.

Technical data	for device type	Item no.
Robust foot switch with connection plug, cable length 2.5 m	High-voltage testing devices/ Combi-testers	F9-1D

### Hand-held start button



Hand-held start button to start the high-voltage and insulation resistance test in combination with a test probe and adapter cable for the PE. This prevents one hand from being free during the test. Delivery includes a connection line (approx. 6 m), wall-mounted holder and plug connector for connecting to the testing device.

Technical data	for device type	Item no.
Cable length: 6 m, 1 pc.	High-voltage testing devices/ Combi-testers	F9-1W

### Barriers



The test station must be demarcated from other workspaces, traffic routes, etc. in accordance with EN50191. This is primarily for the protection of the operator as well as his environment. Elabo barrier posts and plastic chains permit flexible configuration of test stations.

Technical data		Item no.
Metal barrier posts, red/white with robust base, height 1.1 m		94-2H Z01
PVC link chain, red/white for demarcating the test station and attaching to barrier posts. Please indicate length required.		94-2J

### Warning sign



Warning signs must be posted at the test station in accordance with EN 50191. The warning sign is black on yellow in accordance with DIN 40 008 Part 3 with Supplement Part 3. It is required for test systems with voltages greater than 1 kV.

Technical data		Item no.
Plastic warning sign in accordance with DIN 40008 Dimensions: 240 x 200 mm	Other languages on request	94-2E
Adhesive PVC warning sign in accordance with DIN 40008 Dimensions: 120 x 100 mm	Other languages on request	94-2F

### Prohibition sign



A prohibition sign must be posted at the access points to test bays or electrical switching stations if the space does not provide sufficient protection from direct or indirect contact with life-threatening voltage potentials.

Technical data		Item no.
Round prohibition sign made of PVC film, self-adhesive, in accordance with DIN 40008 Part 2. diameter 200 mm	Other languages on request	94-2G

Technical specifications subject to change without notice.



# Test cages

## Test cage

Elabo test cages guarantee the greatest possible protection for the operator. They make it possible to construct a "test station with inherent electric shock protection". The connected high-voltage testing device is only started after the hood has been securely closed. The chambers are suitable for tests up to 8000 VAC or 12000 VDC.



Technical data	Item no.
High-voltage test cage with manually pivotable acrylic glass protective hood. Contact is made with the testing device via a high-voltage cable approx. 2 m long with a special plug and a control line. There is room for additional components, such as a switching matrix, to be installed in the subframe. Contact is made with the test object via an integrated safety socket, laboratory safety receptacles and a ground plate. Interior clearances: W = 430 mm, D = 450 mm, H = 280 mm. Optionally available: other dimensions, removable drawer, test object contacts, "unequipped" model	94-3A
See above. System plug for combi-tester included F7-1A; G7-1A; G7-1B; G7-1G	94-3A ZF01
800 mm wide	94-3A ZB 800
1000 mm wide	94-3A ZB1000

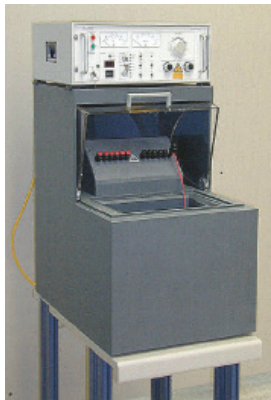

Technical data	Item no.
High-voltage test cage with vertical pneumatically operated hood. A start button (for closing the hood and starting the test) and a reset button (for acknowledging a fault) are built into the front panel. Contact is made with the testing device via a high-voltage cable approx. 2 m long with a special plug and a control line. A maintenance unit with a compressed air connection (5 bar) is built into the back panel. There is room for additional components, such as a switching matrix, to be installed in the subframe. Interior dimensions: W = 490 mm, D = 480 mm, H = 400 mm. Optionally available: other dimensions, drawer, test object contacts.	94-3B
See above. System plug for combi-tester included F7-1A; G7-1A; G7-1B; G7-1G	94-3A ZF01



Technical data	Item no.
Double test chamber for alternating operation with a sliding hood. The two-chamber design allows the test object to be replaced in one test chamber while a test is being performed in the other chamber, thus resulting in very short cycle times. Contact is made with the testing device via a high-voltage cable approx. 2 m long with a special plug and a control line. There is room for additional components, such as a switching matrix, to be installed in the subframe or at the back. Interior clearances per chamber: W = 380 mm, D = 324 mm, H = 200 mm. Optionally available: test object contacts, hood lock, removable adapter system	94-3C Z
See above. System plug for combi-tester included F7-1A; G7-1A; G7-1B; G7-1G	94-3C ZF01



# Special accessories for combination test devices with integrated switching field e.g. G7-1A; G7-1B; G7-1G; F7-1A

## Adapter box



Connection box with 7-pole system plug connector for connecting the test object to the testing device. Model with safety socket and laboratory-type safety receptacles. Typically combined with a two-hand control device and PE test probe. Other cable lengths/models on request.

Technical data	for device type	Item no.
Cable length: 2.5 m	Combi-tester	F9-7A



Connection box with 7-pole system plug connector for connecting the test object to the testing device. Model with safety socket and laboratory-type safety receptacles. Typical in combination with a hand-held start button a high-voltage test probe and a earth-conductor test probe. Other cable lengths/models on request.

Technical data	for device type	Item no.
Cable length: 2.5 m	Combi-tester	F9-7A Z02

## PE adapter cable



Connection cable with 7-pole system plug connector for connecting the test object to the testing device. Typically combined with a high-voltage test probe and hand-held start button. A two-pole model is available for adapting the protective earth conductor to the 4-wire measuring principle. Other cable lengths/models on request.

Technical data	for device type	Item no.
Cable length: 6 m	Combi-tester	F9-7D

## All-pole adapter cable



Connection cable with 7-pole system plug connector for connecting the test object to the testing device. Typically combined with a two-hand control device and PE sensor. A five-pole model is available for bilaterally adapting the protective earth conductor according to the 4-wire measuring principle and the mains side (L/N). Other cable lengths/models on request.

Technical data	for device type	Item no.
Cable length: 6 m	Combi-tester	F9-7E

## High-voltage plug connection



For establishment of plug connections, plug elements designed for this purpose must be used.

Technical data	Article no.
Robust 5-pole high-voltage plug connection for voltages of up to 15 KV eff. with a current carrying capacity of up to 25 A	94-2N
7-pole version	94-2N Z002
9-pole version	94-2Q



Technical specifications subject to change without notice.

# Special accessories for combination test devices with integrated switching field e.g. F7-1B; F7-1C; F7-1N; F7-1P

## Connecting cables



Elabo high-voltage connecting cables with special high-voltage plug connectors. Different connector sockets are incorporated in the devices depending on the device version. Please therefore observe the "For device type" column when selecting.

Technical data	Article no.
Cable length: 2 m, 2 items	94-2B

## PE connecting cable



Elabo cable set with 4 mm laboratory plugs for connection to an external switching field for PE testing. 4-pole version for control according to the four-wire measuring principle. Other cable lengths / versions on request.

Technical data	Article no.
Cable length: 2 m, 4-pole	94-5E Z01

## System drawer extension module



The "System drawer" extension module for the realisation of a complete system. The drawer is used to interconnect the individual tests PE, ISO and HV to the test piece connection. In addition, the safety elements and mains connection for test combination are integrated. Optional extension modules enable individual extension of the system.

Front panel equipment:

- key on-button
- off button
- emergency-off switch with yellow signal ring
- automatic circuit-breaker, 1 pole, C16A for mains supply
- main switchgear

Rear panel equipment:

- mains lead with earthing pin angular plug, 5 m long
- PG11 threaded joint for connection to an external emergency-off circuit
- socket outlet with earthing contact and hinged lid for mains connection of the test device
- modular plug connector for test piece connections
- openings for individual extensions

Typically in combination with a two-hand control and a PE test probe

Technical data	Article no.
System drawer 19" /6 HU	F9-7M

## Extension module for system drawer



The system drawer F9-7M can be individually extended with additional modules. According to the size of the extensions the system drawer increases in overall height. The following modules are merely example configurations. Contact us for your individual requirements. We definitely can offer a solution.

Technical data	Article no.
Extension front connection 1~ In addition the following components are integrated: - German Schuko socket outlet - 4 mm safety laboratory sockets L, N, PE, PE sensor	F9-7M E01
Extension front connection 3~ In addition the following components are integrated: - socket 16A CEE - 4 mm safety laboratory sockets L1.L2. L3. N, PE, PE sense	F9-7M E03
Extension for functional testing 1~ - voltage measurement: 0 .. 250 V - current measurement: 0 .. 16A - power measurement: 0 .. 4000 VA	F9-7M E11
Extension for voltage control 1~ output voltage: 0 .. 250 V	F9-7M E12
Extension for functional testing 3~ - voltage measurement: 3 x 0 .. 450 V - current measurement: 3 x 0 .. 16A - output measurement: 0 .. 10000 VA	F9-7M E13
Extension for voltage control 3~ output voltage: 3 x 0 .. 450 V	F9-7M E14
Extension for connection sockets for high-voltage test probes in the rear panel incl. switching	F9-7M E61

Note: The size of the unit varies depending on configuration  
Technical specifications subject to change without notice.

## Other accessories

### High-voltage relay



For construction of switching units, special switching elements must be used for this purpose.

Technical data	Article no.
High-voltage relay with two changeover contacts Max. switching voltage 5 kV Max. switching current 10A Max. switching output 5000 VA Coil voltage 24 VDC	94-2X
High-voltage relay with one changeover contact Max. switching voltage 5 kV Max. switching current 10A Max. switching output 5000 VA Coil voltage 24 VDC	94-2Y
Conductor card with four high-voltage reed relays Max. switching voltage 10kV Max. switching current 3A Max. switching output 50VA Coil voltage 24 VDC Board also available with one or two relays	94-2U

### High-voltage plug connection



For establishment of plug connections, plug elements designed for this purpose must be used.

Technical data	Article no.
Robust 5-pole high-voltage plug connection for voltages of up to 15 KV eff. with a current carrying capacity of up to 25 A	94-2N
7-pole version	94-2N Z002
9-pole version	94-2Q

### Integrated socket



Technical data	Article no.
5-pole high-voltage integrated socket for voltages of up to 15 kV eff., current carrying capacity up to 25A	94-2P
7-pole version	94-2P Z002
9-pole version	94-2R

### Hochspannungskabel



For high voltage wiring of your test system, we offer special designed high-voltage cables in different diameters and dielectric strengths.

Technical data	Article no.
High voltage cable	on request

Technical specifications subject to change without notice.

# Test sockets

## Test socket



Pneumatically actuated test socket for shock-proof plugs. The test socket is suitable for safety and function tests. With contacts open, the plug can be inserted with minimal effort. PE conductor testing is performed using two "jaws" insulated from each other. This allows a 4-wire measurement to be performed. Housing made of insulating plastic. W=120. D=80. H=75 mm

Technical data		Item no.
Test voltage AC:	max. 3000 V	94-6A
Test voltage DC:	max. 3500 V	
PE conductor test current:	max. 30 A AC	
Function test current:	max. 16 A AC	

Pneumatically actuated test socket for europlugs with PE receptacle. The test socket is suitable for safety and function tests. With contacts open, the plug can be inserted with minimal effort. An additional pneumatically actuated contact pin accommodates the center contact (PE receptacle). PE conductor testing is performed using two "jaws" insulated from each other. This allows a 4-wire measurement to be performed. Housing made of insulating plastic. W=120. D=80. H=100 mm

Technical data		Item no.
Test voltage AC:	max. 3000 V	94-6B
Test voltage DC:	max. 3500 V	
PE conductor test current:	max. 30 A AC	
Function test current:	max. 16 A AC	

## Test socket (superstructure version)



Elabo universal test socket, Protection Class I. Various symmetrical plugs from different countries in protection classes I and II will fit in the test socket for safety and function tests. Please note that the test socket does not provide sufficient electric shock protection. For this reason it may only be used in conjunction with additional protection. Two different versions are offered: built-in or detached. W=120. D=80. H=85 mm

Technical data		Item no.
Country variants:	D/GB/USA/AUS/CH/I	94-6D
Test voltage AC:	max. 3000 V	
Test voltage DC:	max. 3500 V	
PE conductor test current:	max. 30 A AC	
Function test current:	max. 16 A AC	

## Test socket (built-in version)



Technical data		Item no.
Country variants:	D/GB/USA/AUS/CH/I	94-6D Z01
Test voltage AC:	max. 3000 V	
Test voltage DC:	max. 3500 V	
PE conductor test current:	max. 30 A AC	
Function test current:	max. 16 A AC	

## Test socket (detached version)



Elabo universal test socket, Protection Class II. Various symmetrical plugs from different countries in protection class II will fit in the test socket for safety and function tests. Please note that the test socket does not provide sufficient electric shock protection. For this reason it may only be used in conjunction with additional protection. Two different versions are offered: built-in or detached. W=120. D=80. H=85 mm

Technical data		Item no.
s. 94-6E Z01		94-6E

## Test socket (built-in version)



Technical data		Item no.
Country variants:	D/GB/USA/AUS/CH/I	94-6E Z01
Test voltage AC:	max. 3000 V	
Test voltage DC:	max. 3500 V	
Function test current:	max. 16 A AC	

Technical specifications subject to change without notice.

# Base load resistors

The modules shown represent configuration examples. Of course, other combinations/configurations are available on request.

## For PE conductor resistance



Resistor combination installed in an insulating plastic housing for periodic testing of PE conductor resistance testing devices. Not suitable for continuous operation.

Technical data	Item no.
Load resistance 100 / 200 / 300 (combination) mΩ; 25 A; 100 Watt; CT 100 ppm/K	94-4V

## For insulation resistance



Resistor combination installed in an insulating plastic housing for periodic testing of insulation resistance testing devices.

Technical data	Item no.
Load resistance 10 / 100 MΩ; 0.2 Watt	94-4G

## For leakage current



Resistor combination installed in an insulating plastic housing for periodic testing of leakage current testing devices.

Technical data	Item no.
Load resistance 2 x 50 kΩ; For measurement range 10 mA; 3 Watt; 300 ppm/K	94-4A

Resistor combination installed in a shock-proofshock-proof plug housing for periodic testing of leakage current testing devices.

Technical data	Item no.
Load resistance 2 x 500 kΩ; For measurement range 1 mA; 1 Watt; 50 ppm/K	94-4B

## For high voltage



For monitoring contacts by means of basic current or for dummy testing, special high-voltage resistors are required.

Technical data	Item no.
Encapsulated basic load resistor with open cable ends. Resistance value: 1 MΩ; Power: 10 W Models with modified resistance and power values available.	94-2M

Technical specifications subject to change without notice.

# Dummy modules

Dummy modules allow testing devices to be checked for proper function. Data recording and fault detection are checked by simulation of specific measured data. Ideally this takes place using the actual test object contacts so that the connection and wiring can be tested at the same time. Depending on how frequently devices are used for testing, we recommend that checks be performed at regular intervals, at least once daily if possible.

## Dummy module for PE conductor testers



This module, which is integrated into a connector housing, can be used to carry out a dummy test in a simple manner on a device for measuring PE conductor resistance. Two integrated contact plates allow a PE conductor test probe to be applied.

Technical data	Item no.
Dummy module for measuring PE conductor resistance Simulated test object data: Pass: appr. 70 mΩ Fail: appr. 140 mΩ Other values are available on request	94-4V Z801

## Dummy module for high voltage testers



This Elabo dummy module permits a dummy test to be carried out simply on a high-voltage test device. Two integrated contact plates allow the test probe to be applied.

Technical data	Item no.
Dummy module for high-voltage testing Simulated test object data: I approx. 5 mA at 1.000 VAC Other values are available on request.	94-2M Z01

## Dummy modules for combi-testers



Elabo dummy/simulator module for combi-testers for PE conductor, insulation resistance and high-voltage testing. The dummy and simulator module is used to test combi-testers periodically for proper function up to the point of the connection adapter. The module is connected using a shock-proof plug at the test socket on the test adapter or on the testing device. The various test types of the device can then be tested using a special dummy test plan. Jumpers are used to set the relevant pass and fault conditions for the various tests. A contact plate is provided as the contact with the PE conductor test probe.

Technical data	Item no.	
The module consists of a robust plastic housing. W=240. H=90 mm, D=160 mm. Delivery incl. 2 m connection line.	F9-4K	
<b>Simulated test object data:</b>	<b>Pass:</b>	<b>Fault:</b>
PE conductor test	R < 60 mΩ	R > 140 mΩ
Insulation test	R > 17 MΩ	R < 1 MΩ (approx. 800 kΩ)
High-voltage test	I < 5.5 mA bei 1.0 kV	I > 100 mA bei 1.0 kV

# Other components for setting up test systems



Measuring and testing devices from Elabo can be used in a wide range of applications. As individual devices or integrated in computer-based partially or fully automated test systems. With the increasing complexity of test technology and the generally associated requirements of data recording and data processing in automated test systems, the requirements placed on contemporary control systems are also increasing. To control these systems, Elabo offers customized computer systems and accessory components that considerably simplify system configuration for you. Individual configuration of standardized 19"-switching cabinets is also part of our range of services.

**Elabo – long-term reliability in all solutions.**





## Building blocks for your test system

When designing complete test rigs, additional building blocks such as switching cabinets and control units are required in addition to the actual measuring and testing devices. Elabo also provides these tailor-made solutions according to your individual needs. The units depicted below are examples and are representative of our extensive portfolio of available components.

Just ask us – we've got the solution.



# Control systems

## Computer systems



Elabo's industrial computer systems allow the creation of high-performance control systems for automated test systems. The data indicated are examples and change according to requirements and advancement.

Technical data	Item no.
Elabo industrial computer system 19"/4HU Processor: Intel, current version Memory: ≥ 4 GB (as required) Drives: 1 .. 3 ≥ 500 GB HDD 3,5" (RAID on request) DVD-burner: internal drive Slots: 4 .. 8 PCI Operating system: Windows 7® Interfaces: USB Graphics: VGA or DVI ≥ 512 MB Network: 2 x Ethernet 10/100 MBit	95-1B Z
Elabo Rack-PC Processor: Intel, current version Memory: ≥ 4 GB (as required) Drives: ≥ 500 GB HDD 3,5" DVD-burner: external Slots: 1 Operating system: Windows 7® Interfaces: USB Graphics: VGA or DVI ≥ 256 MB Network: 2 x Ethernet 10/100 MBit Servers	95-1D Z

Additional computer systems such as the rack PC can be offered individually.

## Keyboards



Elabo keyboard systems complement our computer systems to meet your needs. Various models allow customized system configuration.

Technical data	Item no.
Elabo keyboard drawer 19"/1 HU incl. touch keyboard	95-1V
Elabo touch standard keyboard for table insert	95-1R Z
Elabo standard keyboard for table insert.	95-1R Z
Elabo swivel arm incl. keyboard stand and VESA monitor support. (Keyboard/monitor not included.)	99-SA Z802
Elabo swivel arm incl. keyboard stand and VESA monitor support and operating console. (Keyboard/monitor not included.)	99-SA Z801

## Monitors



Elabo monitor systems complement our computer systems to meet your needs. Various models allow customized system configuration.

Technical data	Item no.
Standard monitor 17" TFT tabletop model	95-1S TFT17
Standard monitor 19" TFT tabletop model	95-1S TFT19
Standard monitor 22" TFT tabletop model	95-1S TFT22
19"/8HU built-in monitor 15" TFT	95-1S Z15
19"/9HU built-in monitor 17" TFT	95-1S Z17

Additional monitor systems can be offered individually on request.

Technical specifications subject to change without notice.

# Rack systems

## 19" switching cabinets



In addition to our extensive assortment of housings for use with devices, Elabo also offers an extensive range of system racks. The configurations described below are examples; configurations may vary depending on requirements.

Technical data	Item no.
Elabo 19" system rack RAL7035 Consisting of: - 19" screw-mounted basic rack with aluminum basic frame and aluminum side panels for installation components in accordance with DIN 41494 - Top panel made of sheet metal, raised for air flow - Floor plate, closed, in two sections - Side panels made of sheet metal, screwed on - Rear doors made of sheet metal (7HU shortened door) and knockout centered at bottom for filter fan. - Door bearing angle 1 HU at back - Filter fan FL200 mounted in the door - Circuit diagram bag mounted to center of door - door opening 120° incl. security lock - 2 x 19" corner steels with center-mounted IEA hole board, distance to front 19" level 382 mm - Set of 6 depth bars top, middle and bottom - Grounding: conductive connection (4 m <sup>2</sup> ) of all cabinet parts to central ground point in accordance with VDE 0100 protection type IP40.	F9-3A
Elabo system rack 19" / 25 HU W = 600. D = 800. H = 1200 mm	F9-3A
Stationary pedestal extension unit	F9-3A E10
Mobile pedestal extension unit	F9-3A E11
Jack ring top extension unit	F9-3A E30

Technical data	Item no.
Elabo system rack 19" / 38 HU W = 600. D = 800. H = 1798 mm	F9-3D
Stationary pedestal extension unit	F9-3D E10
Mobile pedestal extension unit	F9-3D E11
Jack ring top extension unit	F9-3D E30

Technical data	Item no.
Elabo system rack 19" / 43 HU W = 600. D = 800. H = 2020 mm	F9-3E
Stationary pedestal extension unit	F9-3E E10
Mobile pedestal extension unit	F9-3E E11
Jack ring top extension unit	F9-3E E30

Additional switching cabinet systems such as miniracks or special industry solutions can be offered individually. Air-conditioned solutions are also available.

# Elabo test systems

professional solutions in the most diverse areas

## Individual

In addition to the measuring and test devices, Elabo test systems offers innovative test systems for the widest range of applications.

For more than 30 years now, Elabo has been a recognised partner of the industry and the test and certification bodies.

Finding perfect solutions to suit your requirements is a matter of course for us and represents a constant incentive and daily challenge.

The examples shown on the following pages demonstrate the capability of Elabo in the field of partially and fully automated TestSystems. The very latest CAD systems are used to design these test systems. The result is perfection, right down to the last detail.

## Main industry sectors served:

- Automotive
- Modules and components
- New energy
- Household appliances
- Medical equipment
- Tools

Stovetops

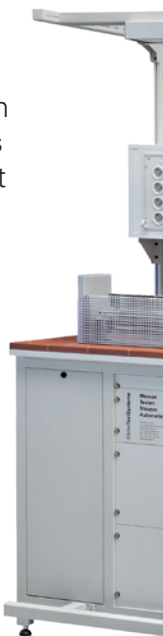
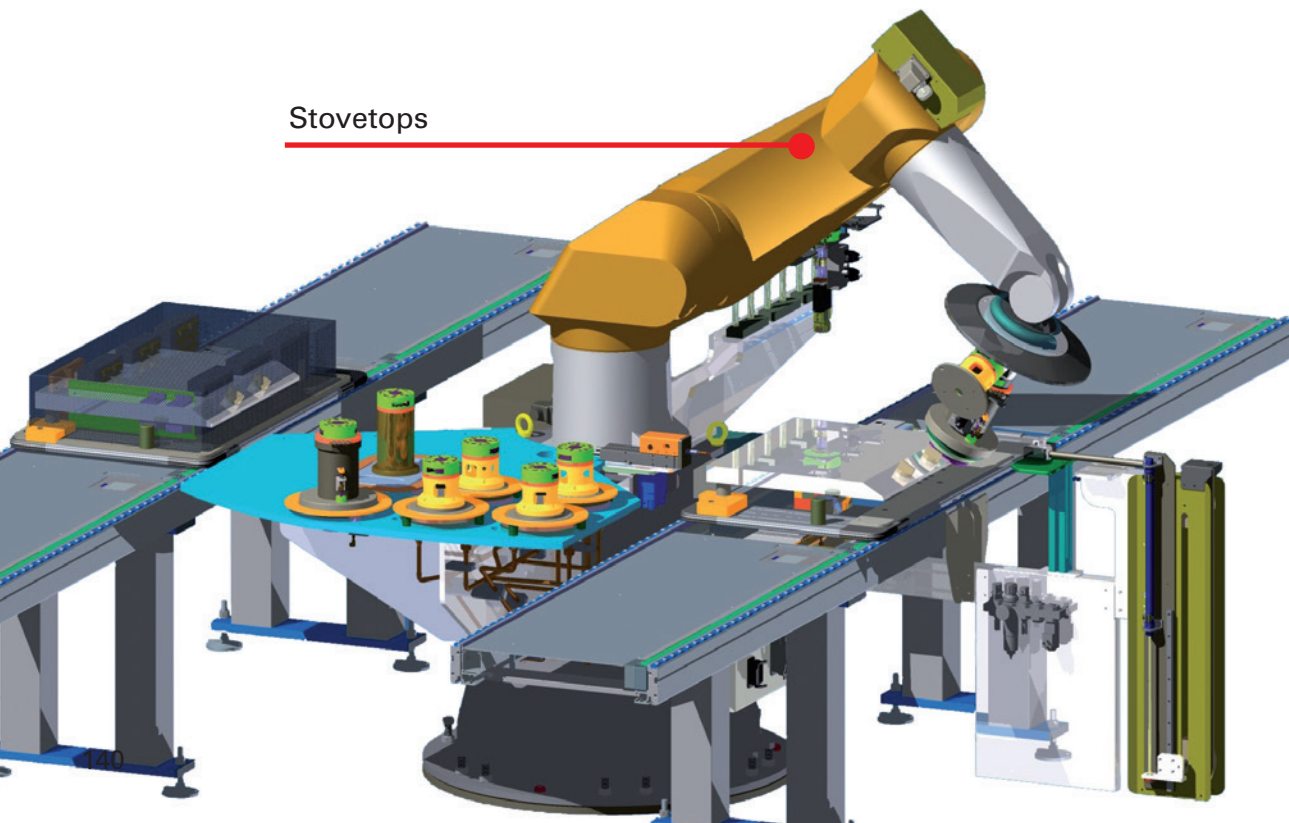



Components



Heating elements

Elektrowerkzeuge



# Elabo test systems

professional solutions in the most diverse areas

## Universal

Our systems make it possible to conduct complete functional and safety testing. The smooth integration in existing production data systems guarantees clear and efficient control in this case in addition to monitoring of the entire production process.



Solar panels, inverters

Warming up measurement  
Energy efficiency measurement



Energy		Washing machine
Manufacturer Model		Logo ABC 123
Low energy consumption		
High energy consumption		
Energy consumption kWh/washing program		
<small>(Based on the results of the standard test for the "cotton" program, 60 °C) The actual energy consumption depends on how the machine is used.</small>		



For more information  
you can order our separate  
brochure TestSystems.

Cable test systems

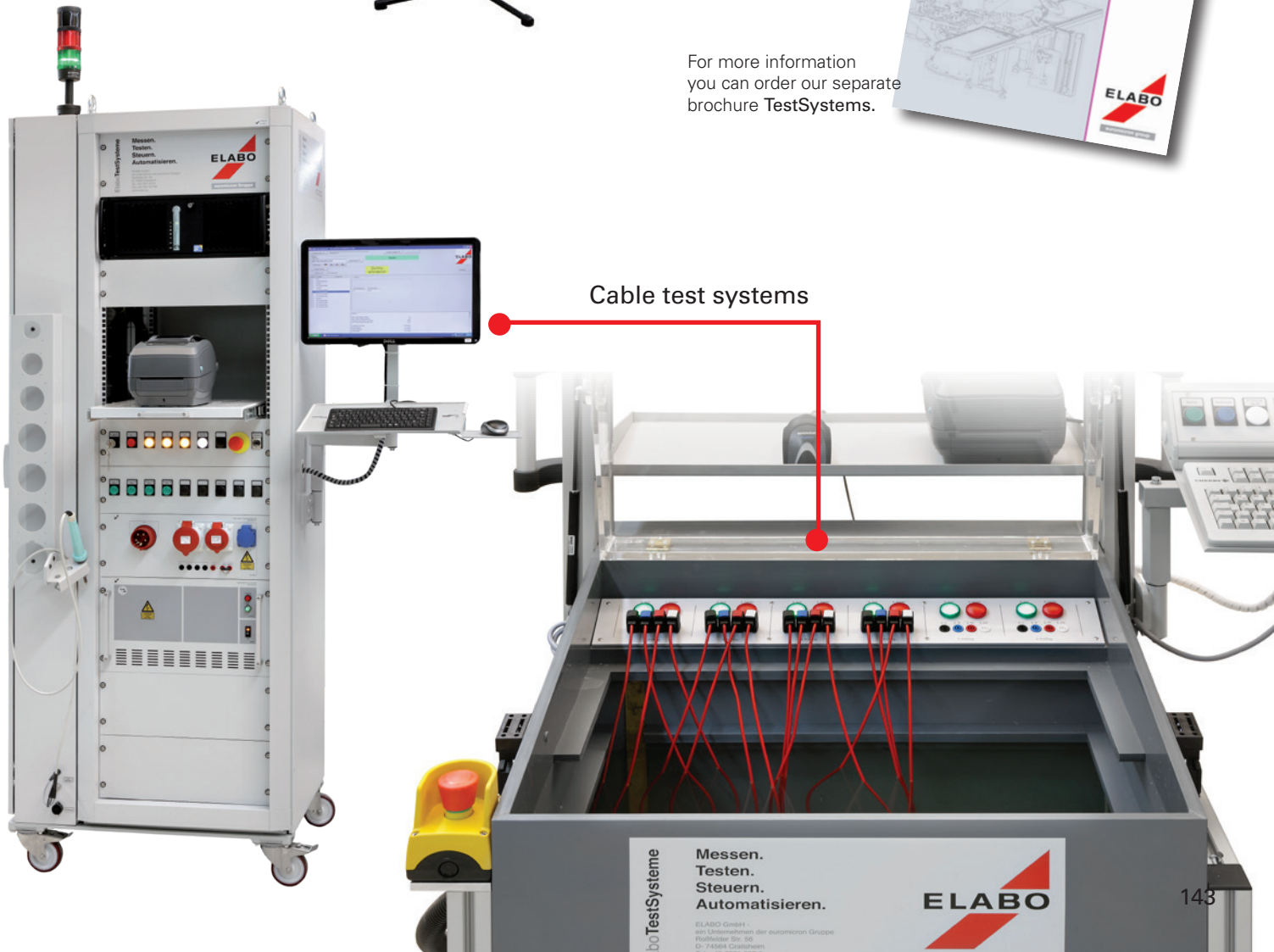

boTestSysteme  
Messen.  
Testen.  
Steuern.  
Automatisieren.



# High-performance software

perfectly tailored to your individual testing duties

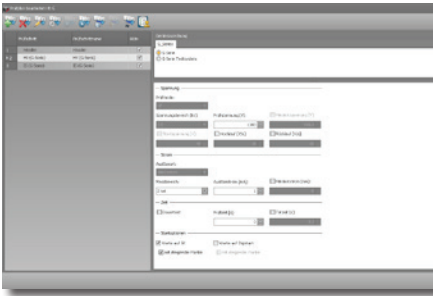

We develop the software ourselves, because only then can we guarantee that everything perfectly goes together. We set new standards in the field of test and inspection software **ELUTION®** with our software for safety and functional test systems and for process automation. Advantages and a greater benefit demonstrated above all by sensible detailed solutions. The economic viability and profitability of the entire test process is considerably enhanced. Even the basic version of the software package **ElutionSystem**, which has been specifically designed for this purpose, provides solutions for typical applications. The entire software package is structured in such a way that any testing job can be carried out from the manual test station using individual devices all the way up to complex, fully automatic systems in an assembly line. In addition, the modules can be individually customized so that any requirement can be specifically met. It goes without saying that the software allows for connection to be made to existing ERP systems.

The following connections can be made for example to:

- SAP R3
- Navision
- Microsoft SQL server
- FTP data transfer
- Oracle

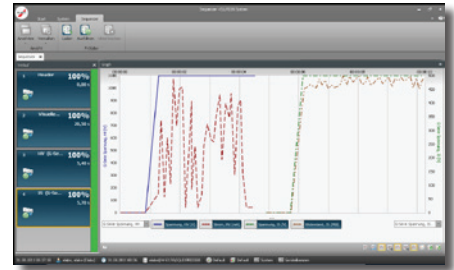

## Sequencer

The type of visualisation in the test program for individual systems depends on the respective functionality.

The duties of the test program often extend far beyond mere process control in this case.

- Test sequence control
- Measured value recording
- Automatic or manual test plan selection
- Partly and fully automatic test sequences
- Control of adaptation and handling units
- Output of interactive user instructions and subjective test directions to the user
- Output of status messages
- Output of fault messages
- Display of the current measured values
- Test piece identification
- Visualisation of parameters
- Direct access to test plan management



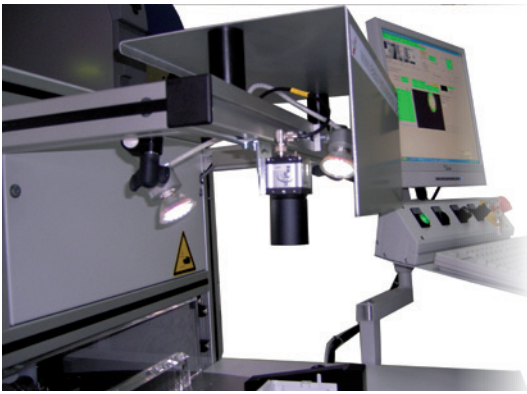

### Additional functions

Additional functions may be required depending on the application and degree of automation. Elabo possess an extensive wealth of experience from a large number of completed projects and has a large number of additionally configurable software modules.

#### Examples

- Automated optical inspection functions
- Noise analysis
- Integration of labelling systems
- Integration of identification systems (barcode, data matrix code, RFID...)
- Integration of marking systems (laser, ink jet printers, embossers...)
- Automated dummy test
- Software-controlled calibration operation
- Handling control
- Production control
- Variant management
- Lot data management

### Data management

We pay attention to details in compiling archive databases. Extensive standard functions are available to the user, in order to allow uninterrupted documentation and therefore traceable proof of testing at any time.

- Subsequent access to archived test results
- Drafting of test protocols in variable protocol models
- Traceability of the test results
- Preparation of statistics on the runtime from the test results
- Archiving of limit/actual values
- Archiving of the inspector ID
- Archiving of the date stamp
- Archiving of the serial number
- Archiving of the tester number
- Export functions (SQL/CSV/Text)

Special report forms, e.g. output as graphic for long-term measurements can be individually offered.



### Production control

Interlinked assembly and test systems from a single source. Elabo produces turnkey systems, including the corresponding connection to the ERP system and control of the conveyor technology

- visualisation
- belt control
- labelling
- production control
- process flow control
- outward transfer of random samples
- plausibility testing
- readiness notification
- evaluation software
- system networking
- data management
- office connection
- production statistics

**Elabo – Limitless modularity to your advantage.**

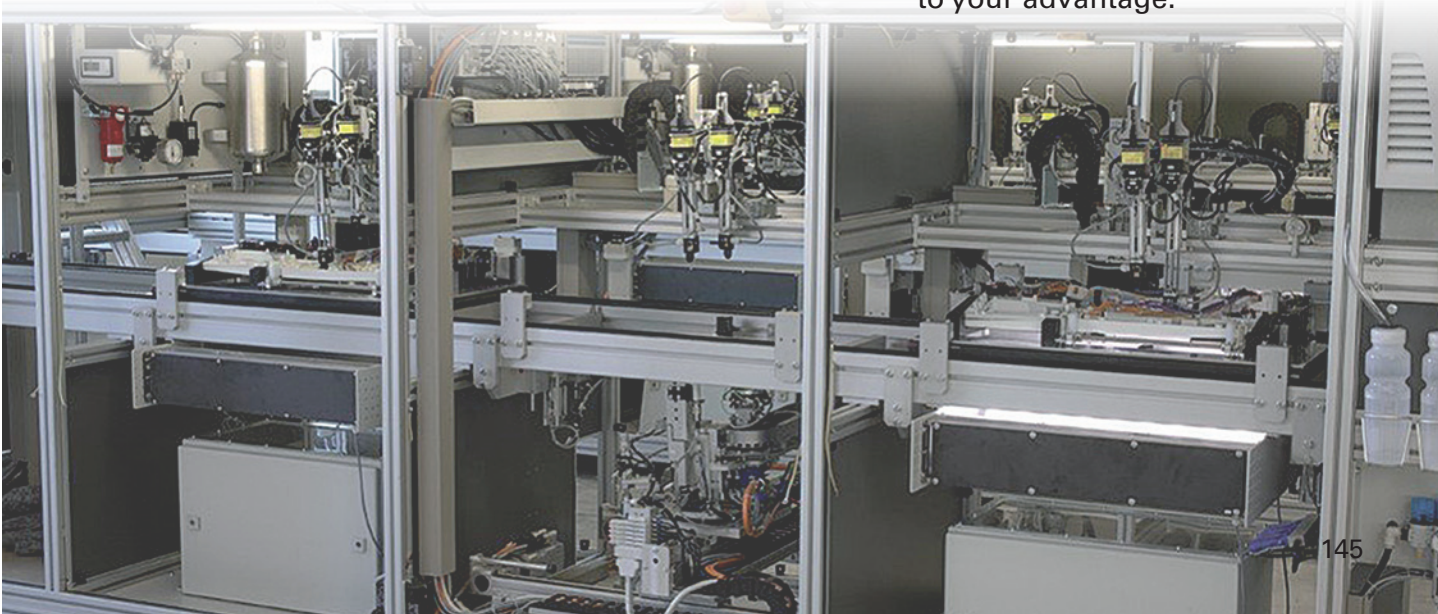

# References

Extract from our customer reference list

ABB  
AEG  
Amica  
Amphenol  
Arcelik  
Bachmann  
Bauknecht  
Benning  
Berger Lichttechnik  
Bosch  
Bosch-Rexroth  
Braun  
BSH  
B. Braun  
Colomix  
Cooper Tools  
CEAG  
Diehl AKO  
Dometic  
Dräger  
EGO  
Eisenmann  
Electrolux  
EPCOS  
ETO  
Ersol  
Elmess  
Fein  
Franke  
Fraunhofer  
Friedrich  
Fronius  
Gardena  
Gedore  
Glen Dimplex  
Grammer  
Göpel Electronic  
Hahn  
Harting  
Hemstedt  
Heidenhain  
Hilti  
Imperial  
Ivoclar  
Julabo  
John Deere  
JUMO  
KACO  
Kärcher  
Komax  
Knipex  
Liebherr  
LG  
Magnet Schultz  
Maquet  
MD Electronic  
Mennekes  
Merten  
Miele  
Molex  
Neff  
PAS  
Petra Electric  
Porsche  
Procter & Gamble  
Promont  
Rexroth  
Richard Wolf  
Riedel  
Robert Bosch  
Rodri  
R.Stahl  
S-Bahn Berlin  
Schaerer  
Schlaeger  
Schleuniger Solutions  
Schneider Electric  
SEV  
SEW Eurodrive  
Sick  
Siemens  
Sirona  
SLG  
SMA  
Solibro  
Stahl  
Steca Elektronik  
Stiebel Eltron  
HPKA  
TDK  
TYCO  
TÜV  
Vaillant  
Vacuumschmelze  
VDE  
Venta  
Viessmann  
Voith Turbo  
WAGO  
Waldmann  
WEETECH  
Whirlpool  
Witte  
Wittenstein  
WMF  
Woodward  
Würth Solar  
Zeiss  
ZF

# Index of order numbers

Item	Page
30	
30-6L	S. 110
30-6M	S. 110
30-6P	S. 110
30-6N	S. 110
30-6R	S. 110
40	
40-1A	S. 110
40-1B	S. 110
40-1C	S. 110
40-1D	S. 110
40-1E	S. 110
40-1F	S. 110
40-1G	S. 110
40-1H	S. 110
40-1J	S. 110
40-1K	S. 110
40-1L	S. 110
41	
41-1N	S. 95
50	
51-4A	S. 110
51-1A	S. 111
51-1B	S. 111
51-1C	S. 111
51-1D	S. 111
51-1E	S. 111
51-1F	S. 111
51-1L	S. 111
90	
90-2A	S. 63
90-2B	S. 63
90-2C	S. 65
90-2E	S. 75
90-2M	S. 87
90-3K	S. 101
90-3N	S. 93
90-3R	S. 93
90-3S	S. 93
90-3T	S. 93
90-4E	S. 67
90-4F	S. 67
90-4G	S. 67
90-4K	S. 73
90-7A	S. 103
90-7B	S. 103
90-7F	S. 105
90-7G	S. 105
92	
92-4A	S. 81
92-4D	S. 83
92-4R Z	S. 81 ff
92-4G	S. 85
92-5K	S. 99
93	
93-1A	S. 111

Item	Page
93-1B	S. 111
93-1C	S. 111
93-1D	S. 111
93-1E	S. 111
93-1F	S. 111
93-1G	S. 111
93-1M	S. 110
93-2B	S. 111
93-2C	S. 111
93-2D	S. 111
93-2E	S. 111
93-2F	S. 111
93-2G	S. 111
94	
94-1R	S. 110
94-1S	S. 110
94-1T	S. 110
94-2A	S. 113
94-2B	S. 113
94-2C	S. 113
94-2E	S. 114
94-2F	S. 114
94-2G	S. 114
94-2H	S. 114
94-2J	S. 114
94-2M	S. 122
94-2N	S. 120
94-2P	S. 120
94-2Q	S. 120
94-2R	S. 120
94-2U	S. 120
94-2X	S. 120
94-2Y	S. 120
94-3A	S. 115
94-3B	S. 115
94-3C	S. 115
94-4A	S. 122
94-4B	S. 122
94-4G	S. 122
94-4K	S. 123
94-4V	S. 122
94-5A	S. 119
94-5B	S. 119
94-5E	S. 118
94-6A	S. 121
94-6B	S. 121
94-6D	S. 121
94-6E	S. 121
94-8A	S. 97
94-8R	S. 97
94-8F	S. 97
95	
95-1B	S. 126
95-1D	S. 126
95-1R	S. 126
95-1S	S. 126

Item	Page
95-1V	S. 126
99	
99-SA	S. 126
F1	
F1-1A	S. 25
F1-1B	S. 27
F1-1C	S. 29
F1-1D	S. 31
F1-1M	S. 25
F1-1N	S. 27
F1-1P	S. 29
F1-1Q	S. 31
F7	
F7-1A	S. 49
F7-1B	S. 51
F7-1C	S. 53
F7-1M	S. 49
F7-1N	S. 51
F7-1P	S. 53
F9	
F9-1A	S. 113
F9-1D	S. 114
F9-1W	S. 114
F9-1L	S. 113
F9-7A	S. 116
F9-7D	S. 116
F9-7E	S. 116
F9-7G	S. 117
F9-7M	S. 118
G1	
G1-1A	S. 19
G1-1B	S. 21
G1-1G	S. 23
G1-1M	S. 19
G1-1N	S. 21
G1-1T	S. 23
G7	
G7-1A	S. 43
G7-1B	S. 45
G7-1G	S. 47
G7-1M	S. 43
G7-1N	S. 45
G7-1T	S. 47
T	
T0-1T	S. 112
N	
N2-1A	S. 19 ff
N3-4P	S. 95

